



RULES FOR INTERNATIONAL COMBINED DRIVING EVENTS

10th Edition, effective 1 January 2009

Updates effective 1 January 2011

Printed in Switzerland
Copyright © 2009 Fédération Equestre Internationale
Reproduction strictly reserved

Fédération Equestre Internationale
Avenue Rumine 37
1005 Lausanne
Switzerland

t +41 21 310 47 47
f +41 21 310 47 60
info@fei.org
www.fei.org

Preamble	1
Article 900: THE WELFARE OF THE HORSE	2
Article 901: HARNESS AND CARRIAGE	2
Article 902 PRINCIPLES	3
Article 903 DEFINITIONS	4
Article 904 ORGANISATION	4
Article 905 SCHEDULE AND ELIGIBILITY	5
Article 906 JUDGES	9
Article 907 TECHNICAL DELEGATE	11
Article 908 VETERINARY DELEGATE/ VETERINARY COMMISSION	12
Article 909 STABLE SECURITY	12
Article 910 COURSE DESIGNER	12
Article 911 FEI CHIEF DRIVING STEWARD	13
Article 912 APPEAL COMMITTEE	13
Article 913 CONDITIONS FOR PARTICIPATION	14
Article 914 HORSES	15
Article 915 PASSPORTS	15
Article 916 IDENTIFICATION NUMBER	15
Article 917 PARTICIPATION	16
Article 918 VEHICLES	17
Article 919 HARNESSES	18
Article 920 SHOES	18
Article 921 SUBSTITUTIONS	18
Article 922 DECLARATION OF STARTERS	19
Article 923 ORDER OF STARTING	19
Article 924 EXAMINATION AND INSPECTIONS	20
Article 925 CLASSIFICATION	22
Article 926 OUTSIDE ASSISTANCE	23
Article 927 CRUELTY	23
Article 928 TRAVEL, EXPENSES AND ACCOMMODATIONS	24
Chapter II COMPETITION A – DRIVEN DRESSAGE	24
Article 929 PRINCIPLES	24
Article 930 THE ARENA	24
Article 931 DRIVEN DRESSAGE TESTS	24
Article 932 CONDITIONS	25
Article 933 JUDGING	25
Article 934 MOVEMENTS	25
Article 935 GENERAL IMPRESSION	27
Article 936 SCORING	28
Article 937 SUMMARY OF DRIVEN DRESSAGE PENALTIES	29
Article 938 CLASSIFICATION	29
Chapter III COMPETITION B – MARATHON	30
Article 939 GENERAL	30
Article 940 COMPETITORS	30
Article 941 THE COURSE	30
Article 942 OBSTACLES IN SECTION E	31
Article 943 INSPECTION OF THE COURSE	32
Article 944 TIMES	33
Article 945 PENALTIES ON THE MARATHON COURSE	34
Article 946 OBSTACLE PENALTIES	35
Article 947 JUDGES	36
Article 948 OFFICIALS	36
Article 949 CLASSIFICATION	37
Chapter IV COMPETITION C: OBSTACLE-CONE DRIVING	40
Article 950 GENERAL	40
Article 951 THE COURSE	40

Article 952	OBSTACLES	41
Article 953	COMPETITION C SUMMARY	42
Article 954	THE FAULT COMPETITION	43
Article 955	STARTING ORDER	43
Article 956	PENALTIES	43
Article 957	SUMMARY OF PENALTIES IN COMPETITION C.....	45
Article 958	DRIVE- OFF	47
Article 959	TIME COMPETITION	47
Article 960	COMPETITION IN TWO SECTIONS.....	48
ANNEX 1:	CLASSIFICATION OF INTERNATIONAL JUDGES.....	49
1.	Categories of Judges.....	49
2.	Qualification Requirements for Judges.....	49
3.	Promotion of Judges	49
4.	Limitations	49
ANNEX 2	CLASSIFICATION OF COURSE DESIGNERS	51
1.	Categories of International Course Designers.....	51
2.	Qualification Requirements for Course Designers	51
3.	Promotion of Course Designers.....	51
4.	Limitations	51
ANNEX 3	CLASSIFICATION OF TECHNICAL DELEGATES	53
1.	Categories of Technical Delegates	53
2.	Qualification requirements for Technical Delegates	53
3.	Promotion of Technical Delegates	53
4.	Limitations	53
ANNEX 4	DIAGRAM OF THE DRESSAGE ARENA for Test 8a	55
ANNEX 4A	DIAGRAM OF THE DRESSAGE ARENA.....	56
ANNEX 5	DIAGRAM OF THE SMALL DRESSAGE ARENA	57
ANNEX 6	RULE DIFFERENCES FOR <i>FIVE SECTION MARATHONS</i>	58
Article 941	THE COURSE.....	58
ANNEX 7	CLOSED MULTIPLE OBSTACLES	59
1.	Single "L"	59
2.	Double "L"	59
3.	Single "U"	61
4.	Double "U"	62
5.	Box	63
6.	Double Box.....	63
ANNEX 8	OPEN MULTIPLE OBSTACLES	65
1.	SERPENTINE Art 952.3.....	65
2.	ZIG-ZAG: Art 952 .3	66
ANNEX 9	THE BRIDGE Art 952.4	67

Rules for International Combined Driving Events

Preamble

This edition of the Rules for International Combined Driving Events comes into force on 1st January 2009. As from this date, all other texts covering the same matter (including other editions, official minutes, memoranda or bulletin) issued previously are superseded.

Although this Document sets out the detailed Rules of the FEI governing International Combined Driving Events, it must be read in conjunction with the current Statutes, General Regulations, Veterinary Regulations of the FEI and the Annexes, which form part of these Rules together with any amendments.

Every eventuality cannot be provided for in these Rules. In any unforeseen or exceptional circumstances it is the duty of the Ground Jury to make a decision in a sporting spirit, taking into consideration whether advantage has been gained, and the Welfare of the Horse. Their decision should reflect as closely as possible the intention of these Rules and the FEI General Regulations.

Throughout this publication, the word "Horse" shall mean Horse and/or Pony; the masculine shall also include the feminine and the singular the plural unless otherwise stated in a specific Rule. A separate publication, "Guidelines for Organisers and Officials" expands on the interpretation of the Rules. The most recent edition is available from the FEI web site: <http://www.fei.org>

CHAPTER I GENERAL

Article 900: THE WELFARE OF THE HORSE

The Fédération Equestre Internationale (FEI) requires all those involved in international equestrian sport to adhere to the FEI's Code of Conduct and to acknowledge and accept that at all times the Welfare of the Horse must be paramount and must never be subordinated to competitive or commercial influences.

- 900.1** At all stages during the preparation and training of Competition Horses, Welfare must take precedence over all other demands. This includes good horse management, training methods, farriery, tack, and transportation.
- 900.2** Horses and Competitors must be fit, competent and in good health before they are allowed to compete. This encompasses medication use, surgical procedures that threaten welfare or safety, pregnancy in mares and the misuse of aids.
- 900.3** Events must not prejudice Horse Welfare. This involves paying careful attention to the Competition areas, ground surfaces, weather conditions, stabling, site safety and fitness of the Horse for onward travel after the event.
- 900.4** Every effort must be made to ensure that Horses receive proper attention after they have competed and that they are treated humanely when their competition careers are over. This covers proper veterinary care, competition injuries, euthanasia and retirement.
- 900.5** The FEI urges all involved with the sport to attain the highest levels of education in their areas of expertise.

A full copy of the FEI Code of Conduct for the Welfare of the Horse can be obtained from the Fédération Equestre Internationale, Avenue Rumine 37, CH- 1000, Lausanne 5, and Switzerland. Telephone: +41 21 310 47 47. The Code is available in English and French. The Code is also available on the FEI's website: www.fei.org

Article 901: HARNESS AND CARRIAGE

- 901.1** Minimum distance between Horse and Carriage when in draft (fender rolls: 40 cm, roller bolts: 50 cm).
- 901.2** Swingle trees for Horses: at least 60 cm wide.
- 901.3** Pole length: Poles for both Horses and Ponies should extend to approximately the middle of the length of the necks when in draft; except when using a Yoke.
- 901.4** Horse Yoke width: 45 cm. minimum. Yokes must not be behind any part of the shoulder. Pole Straps must be of sufficient length to allow free movement of the Horses.
- 901.5** For Horse Four- in- Hand leaders, the lead bar must measure at least 1m and the swingle trees at least 50 cm.
- 901.6** For Horse Singles, the distance between Horse and Carriage when in draft must not be less than 50 cm.
- 901.7** Any nosebands, attachments or ancillary equipment, which impedes or is likely to impede the free intake of air into the nostrils of the Horse or Pony, are not permitted.
- 901.8** Blinkers and ancillary equipment on both Horses and Ponies must not impede forward vision or be so close to the eyes as to irritate them.
- 901.9** The minimum distance between the Pony and the Carriage when in harness must be such that there is no interference with the free movement of the Pony.
- 901.10** Swingle trees and leader bars must be of sufficient width so as not to impede the free movement of the Pony or Ponies.
- 901.11** Yoke width or Pole Straps must be sufficient to allow the free movement of the Ponies.

Rules for International Combined Driving Events

901.12 Safety

- 901.12.1 At the event location whenever the horse(s) are fully harnessed or being harnessed to a vehicle, groom(s) must at all times be in attendance and able to render assistance if needed.
 - 901.12.2 The Driver may only dismount from the vehicle when grooms are at the horses' heads, or the reins are given to another responsible person on the carriage.
 - 901.12.3 No horse may be led from a moving carriage.
- 901.13** For contravening any of these rules, a verbal warning or Yellow card must be given by the Ground Jury. Subsequent offences at the same event will entail a second yellow card.

Article 902 PRINCIPLES

902.1 International Rules

These Rules are intended to standardise International Combined Driving Events, as far as is possible, but the conditions at such Events must be fair and similar for all Competitors. It is therefore necessary to lay down a number of strict and comprehensive Rules for the conduct of International Events.

902.2 Discretion

It is essential that all International Championships and any other Event described as "International", follow these Rules.

However, Organising Committees, while observing these Rules, may use their discretion to make their Events interesting and challenging for the Competitors and attractive to spectators.

902.3 Penalties

- 902.3.1 The Rules concerning the Event and each Competition must be strictly enforced by the Ground Jury. Competitors, who fail to comply with these Rules, may incur Disqualification or Elimination, unless some other penalty is prescribed in the relevant Article.
- 902.3.2 Yellow Warning Card- Where there is abuse of Horses in any form or incorrect behaviour towards Event Officials or any other party connected with the Event, the President of the Ground Jury, the President of the Appeal Committee and the FEI Chief Driving Steward, through the President of the Jury, as an alternative to instituting the procedures foreseen in the legal system, may deliver to the Person Responsible a Yellow Warning Card (s).
(See General Regulations)

902.4 Disqualified (D)

- 902.4.1 Competitors and Horses may be Disqualified for contravening certain of these Rules at any time during an Event. A Competitor or Horse who has been Disqualified is prohibited from taking any further part in the Event or win any prize. Disciplinary action may be taken subsequently by the National Federation of the offender or by the FEI if the incident is reported to the FEI by the Foreign Judge or Appeal Committee, or a Yellow Card has been issued.

902.5 Eliminated (E)

- 902.5.1 Competitors may be Eliminated from a Competition as a penalty for contravening certain Rules during the Competitions.
- 902.5.2 Competitors who are Eliminated in Competition A may compete in Competitions B and C. Competitors and Horses who are Eliminated in Competition B may compete in Competition C.

902.6 Retired (R)

- 902.6.1 Competitors, who, for any reason, do not wish to continue, may decide to Retire during any of the Competitions. If a Competitor Retires in a Competition he may be permitted to compete in the following Competitions.

Rules for International Combined Driving Events

902.7 Withdrawn (W)

902.7.1 Competitors are deemed to have Withdrawn if, for any reason, they fail to start in any of the Competitions. Once Withdrawn, Competitors cannot take any further part in the Event.

902.8 Lamé or Unfit Horses

If a Horse is deemed to be lame or unfit by:

902.8.1 The Judge at C in Competition A, the Horse must be Disqualified and may not compete in any other Competition.

902.8.2 A Member of the Ground Jury in Competitions B or C, the Horse will be Eliminated.

902.9 Placings and Prize Money

902.9.1 Competitors who Retire or are Eliminated from any Competitions may not be placed in that Competition or in the Final Classification.

902.9.2 Competitors may only receive Prize Money in Competitions in which they have competed without Disqualification, Elimination or Retirement.

ARTICLE 903 DEFINITIONS

903.1 Combined Driving Event

A series of one or more Competitions that commences one hour before the beginning of the scheduled First Horse Inspection and concludes one half hour after the announcement of the Final Results.

903.2 Competition

A component of a Combined Driving Event: such as Competition A – Driven Dressage; Competition B – Marathon; Competition C – Obstacle Cones Driving.

903.3 Dismounting

903.3.1 The deliberate departure of a Competitor or Groom from the Vehicle. Art. 946.3 Art 956.5

903.3.2 The accidental leaving (falling out) of the Vehicle by the Competitor or Grooms. Art 946.3 Art 956.5

903.4 Driving Event Location

All land used for the Competitions Comprising the Event, and areas for exercising, stabling and the parking of vehicles.

903.5 Entry

The Competitor (Driver), Horses, Grooms, Harness and Vehicle appropriate to the turnout as defined in these Rules.

903.6 Event Official see Gen Regs

903.7 Horse

Refers to a Horse or Pony authorized to compete under Article 914

903.8 Organising Committee (OC) see Gen Regs.

903.9 Schedule

The official document compiled by the Organising Committee and approved by the FEI describing details of the Event.

Article 904 ORGANISATION

904.1 Events

The various individual and Team Championships are as follows:

904.1.1 The World Four-in-Hand Championship for Horses CH-M-A-4

904.1.2 The World Pair Championship for Horses CH-M-A-2

904.1.3 The World Singles Championship for Horses CH-M-A-1

904.1.4 The Combined World Pony Driving Championships CH-M-A-P 1, 2, 4

904.2 Organisation

904.2.1 In principle all Championship Events must be organised in accordance with the General Regulations and the Rules for Combined Driving Events.

904.2.2 In even years, the FEI will invite NFs to organise the World Four-in-Hand Championship for Horses and the World Single Driving Championship for Horses.

Rules for International Combined Driving Events

904.2.3 In odd years, the FEI will invite NFs to organise the Combined World Pony Driving Championship and the World Pair Driving Championship for Horses.

904.3 Choice of Event

904.3.1 Championships and *Concours d'Attelage Internationaux Officiels* (CAIO) must always include all three Competitions.

904.3.2 Organising Committees of International Driving Events (CAI) may include two, or three, of these Competitions, but in any such combination. Competition B (Marathon) is to be considered the most important, and it may take place before or after Competition A. When Competition C is included, it must be the last to take place.

904.3.3 National Events (CAN), at which no more than eight foreign Competitors from up to four nations may take part.

904.4 Choice of Classes

All, or any, of the following classes may be held at the same Event, but each must be classified separately:

Horse Single	Pony Single
Horse Pair	Pony Pair
Horse Tandem	Pony Tandem
Horse Four in Hand	Pony Four in Hand

904.5 Types of Events

There are four types of International Events:

	National Teams	Prize money	Marathon
Championship	Yes	Yes	3 section
CAIO	Yes	Yes	3 section
CAI-A	No	Yes	3 section *
CAI-B	No	Optional	3 section *

* A 5 Section marathon is allowed for Four-in-Hands or Pairs only, if approved by the Organising Committee and published in the Schedule. See Annex 6 for differences.

904.6 Additional Events

Organising Committees may arrange a CAI- A or CAI- B for other Classes during Championships and CAIO events. These additional Events must also comply with these Rules. The same Marathon Course may be used for all Classes, but the CAI Competitions must follow the Championship or CAIO Competitions.

904.7 Choice of Date

904.7.1 Requests to organise a CAI- A must be forwarded to the Secretary General of the FEI not later than the first of October in the year before the Event is due to take place (General Regulations, Art 102)

904.7.2 Requests to organise a CAI- B must be forwarded to the Secretary General of the FEI not later than 16 weeks before the Event (See General Regulations).

904.7.3 Request to organise a CAIO or Championship must follow the General Regulations.

904.8 Officials

904.8.1 The President and Members of the Ground Jury must be appointed in accordance with Article 906.

904.8.2 The Technical Delegate must be appointed in accordance with Article 907.

904.8.3 The Course Designer must be appointed in accordance with Article 910.

904.8.4 The FEI Chief Driving Steward must be appointed in accordance with Article 911.

904.8.5 The composition and the appointment of the Appeal Committee must follow the requirements laid down in Article 912.

ARTICLE 905 SCHEDULE AND ELIGIBILITY

905.1 Draft Schedule

At least 16 weeks before the Event is due to take place, the Organising Committee of a Championship, CAIO, CAI-A or CAI-B must send a Draft Schedule to the Secretary General of the FEI, through their National Federation for approval by the FEI. The Draft

Rules for International Combined Driving Events

Schedule must set out the general conditions for each proposed Competition, as well as any particular conditions that they may wish to introduce, which are not covered by the Rules.

After approval by the Secretary General of the FEI, the Schedule, and invitations of entry to the Event should be sent to all affiliated NFs by the NF of the host country and not direct to individuals.

905.2 The Definite Schedule

The Organising Committee must send a Definite Schedule to the FEI at least 4 weeks before any of the Events mentioned in 1 above, with a copy of the programme.

905.3 Eligibility Procedure for Championships

905.3.1 Eligibility requirements for each World Championship shall be published on the FEI website ~~and in the Bulletin~~ at least 18 months before the respective Championship, if practical.

905.3.2 The FEI shall also publish the maximum driven penalty points allowed at the Championship in Competition A, Driven Dressage, by which the Driver concerned shall be qualified to continue into Competition B and C. The Ground Jury will have the final decision as to whether the Competitor may continue into Competition B and C, taking in to account any contributing factors. There will be no Appeal.

905.3.3 Competitors and Horses are not required to qualify as combinations, but in the same Class as they intend to compete in.

905.3.4 For all FEI World Championships it is the responsibility of each National Federation to prove that their Entries meet the eligibility requirements. Certificates of Capability and Records of Results must be sent by NFs to the Organising Committee with their Nominated Entries, without which, the entries will not be valid. See Gen. Regulations.

905.3.5 National Federations giving incorrect information will be reported to the FEI Judicial Committee.

905.3.6 National Federations wishing to use National Events as Qualifiers, for Competitors and Horses, must obtain prior permission from the FEI and have at least 2 International Driving Judges, both to be approved by the FEI and one must Foreign. Only the Driven Dressage scores from the International Judges will count towards the Qualification.

905.4 The World Four in Hand Championship for Horses

905.4.1 Each NF may enter a maximum of six Four- in- Hand Competitors with a maximum of ten Horses per Four- in- Hand on the Nominated Entry List and a maximum of three Four- in-hand Competitors with a maximum of five Horses per Four- in-hand on the Definite Entry List.

905.4.2 Should a NF only be able to send two Competitors, they must be entered as a Team.

905.4.3 In addition, each NF is entitled to send a Chef d'Equipe and Veterinarian, both of whom will be accorded the same privileges as the Competitors.

905.4.4 A NF which cannot send a Team may enter one Competitor as an Individual under the conditions set out in 4.1

905.5 The World Pair Championship for Horses

905.5.1 Each NF may enter a maximum of six Pair Competitors with a maximum of six Horses per Pair on the Nominated Entry List and a maximum of three Pair Competitors with a maximum of three Horses per Pair on the Definite Entry List.

905.5.2 Should a NF only be able to send two Competitors, they must be entered as a Team.

905.5.3 Each NF is entitled to send a Chef d'Equipe and Veterinarian, both of whom will be accorded the same privileges as the Competitors.

905.5.4 A NF which cannot send a team may enter one competitor as an individual under the conditions set out in 5.1.

905.6 The World Singles Championship for Horses

905.6.1 Each NF may enter a maximum of six Single Competitors with a maximum of two Horses per entry on the Nominated Entry List and three Single Competitors with a maximum of one Horse per Competitor on the Definite Entry List.

905.6.2 Should a NF only be able to send two Competitors, they must be entered as a Team.

905.6.3 Each NF is entitled to send a Chef d'Equipe and Veterinarian, both of whom will be accorded the same privileges as the Competitors.

Rules for International Combined Driving Events

- 905.6.4 A NF which cannot send a Team may enter one Competitor as an Individual under the conditions set out in 6.1.
- 905.6.5 A spare Horse from the Nominated List may be entered per National Team. The Competitor who uses the spare Horse will be eligible for the individual classification, as well as for the Team classification. The spare horse can only be substituted once, not later than one hour before the start of Competition A and notified in writing to the Organiser.

905.7 The Combined World Pony Driving Championships

- 905.7.1 A National Team shall consist of at least one Single, one Pair and one Four-in-Hand and each Nation is entitled to send up to a maximum of six Competitors consisting of up to two Single, two Pair and two Four- in-Hand Competitors.
- 905.7.2 The number of Ponies shall be as follows:

Class	Nominated Entries	Definite Entries
Single	2	1
Pair	6	3
Four- in- Hand	10	5

- 905.7.3 NFs which cannot send a Team may send up to 2 Competitors in each Class.
- 905.7.4 A Spare Pony may be entered for the Single Class. The Competitor who uses the Spare Pony will be eligible for the individual classification as well as for the Team classification. The spare Pony can only be substituted once not later than one hour before the start of Competition A and must be notified in writing to the Organiser.
- 905.7.5 The Host Nation is entitled to 2 individual Entries per Class.
- 905.7.6 Each NF is entitled to send a Chef d'Equipe and Veterinarian, both of whom will be accorded the same privileges as the Competitors.

905.8 Entries

- 905.8.1 The number of Horses that may be entered for an Event must be in accordance with the schedule.
- 905.8.2 All competitors invited or nominated for an International Event must be entered by their NFs. All foreign competitors selected by their NFs must be accepted by the OC. OCs may not accept any other entries.
- 905.8.3 NFs may only enter competitors for FEI World Championships who are qualified under conditions decided by the relevant Technical Committee and approved by the Bureau.
- 905.8.5 Under no circumstances may the OC limit the number of entries of eligible competitors or teams for a FEI Championship.
- 905.8.6 Entries for FEI Championships for Seniors must be made following the compulsory three phases outlined under paragraph 905.8.6.1, 905.8.6.2 and 905.8.6.3 below.
- 905.8.6.1 Entries in principle must reach the OC at least eight weeks before the Event is due to begin. Entry in principle means that an NF has the definite intention of sending

Rules for International Combined Driving Events

competitors to participate in the Event. It must state whether the intention is to send only individuals, only a team or a team and individuals.

- 905.8.6.2 Nominated entries must reach the OC at least four weeks before the Event and must include a list of the names of competitors and Horses from which the Definite Entries and any substitutions will be chosen and state the number of competitors and Horses which the NF intends to send. The number of nominated entries of competitors and Horses must not exceed twice the number invited in the Schedule. Once the nominated entries have been sent in, NFs may send fewer competitors and/or Horses but never more than the number of nominated entries. NFs which are not represented after having made nominated entries and whose excuse is not acceptable to the OC shall be reported by the OC to the Secretary General for consideration of their excuse by the FEI Tribunal.
- 905.8.6.3 Definite entries must reach the OC at the latest four days preceding the beginning of the Event. These represent the final selection of competitors and Horses that will travel to the Event. The Definite Entries may not exceed the number listed and must be chosen from the list of names on the Nominated Entries. After the Definite Entries have been sent in, substitutions of Horses and/or competitors may only be made with the express permission of the OC.
- 905.8.7 Entry forms for Horses must include the name/names, breed, sex, age, colour, country of birth, present nationality and passport number and, where appropriate, qualifications.
- 905.8.8 Should an NF send more competitors and/or Horses than shown in the Nominated Entry the OC is not obliged to accommodate them or to allow them to participate in that Event.
- 905.8.9 At an Event, a competitor may withdraw any or all his Horses from a Competition, but he may not add a Horse not previously entered for that Competition without the Approval of the OC and the Ground Jury.
- 905.8.10 Where an NF has made a nominated entry of a team and finds that it will be unable to send a team, it must immediately inform the OC.
- 905.8.11 Teams or individual competitors who have been definitely entered by their NFs at any Event and fail to take part without valid excuse must be reported by the Foreign Judge/Technical Delegate to the Secretary General for consideration by the FEI Tribunal. Competing at another Event staged at the same time does not constitute a valid excuse for failure to participate at an Event.
- 905.8.12 An NF cannot make definite entries for the same competitor/Horse combinations to more than one OC on penalty of disqualification of such competitor/Horse combinations from the Event where they eventually participate.
- 905.8.13 Withdrawals after the date of definite entries or no-shows will be liable to reimburse the OC for the financial loss incurred by the OC (i.e. stabling and hotel Expenses) as a result of late withdrawal or no-show.

905.9 Entries CAIs

- 905.9.1 CAI-A and CAI-B are primarily for Individual Competitors and there is no restriction on the number of Competitors or the number of Nations that may be entered.
- 905.9.2 At a CAI-B, foreign Competitors living in the Host Nation may participate, with approval of the host NF, at Events held in the country in which they are living.

905.10 Entries Championships and CAIOs

Championships and CAIOs are open to National Teams. A National Team consists of three Competitors of the same Nationality. In the event that a Nation can only send two Competitors, they must be entered as a Team. An Entry from a Nation able to only send one Entry shall be classified as an Individual Entry.

905.11 Additional Individual Entries

- 905.11.1 At the discretion of the Organising Committee all National Federations who have submitted a Nominated Entry for a Team may be invited to enter Additional Individual Entries.
- 905.11.2 The Host Nation may enter up to 3 Additional Individual Entries. For Combined Pony Championships, 2 per class. Exceptions may be granted by the FEI Driving Committee in conjunction with the Technical Delegate.
- 905.11.3 A second Nominated Entry Date shall be specified in the Schedule should the Organising Committee decide to invite National Federations to submit Additional Individual Entries.

Rules for International Combined Driving Events

905.11.4 The number of Nominated Competitor Entries may be twice the number permitted for Definite Entries as outlined in ~~10.1 and 10.2~~ 905.11.2 above

Article 906 JUDGES

906.1 Judges

All International Events must have at least three but not more than five Judges for each class. Collectively, the Judges form the Ground Jury for the Event.

906.2 Composition of the Ground Jury (See General Regulations)

906.2.1 Ground Jury
(Minimum requirements)

Rules for International Combined Driving Events

Category	Judges	President Of Jury	Foreign Judge	Ground Jury
Championships	5	Foreign Official	Official	1 Official and 2 International or above
CAIO	5	Official	Appointed by FEI Official or International	3 Others can be Official or International
CAI -A	5	Official or International	Official or International	1 Official or International and 2 Candidates or above
CAI-A	3	Official or International	Official, International	1 Official or International
CAI-B	5	Official or International	Official, International or Candidate	3 FEI List or Senior Level National
CAI-B	3	Official or International	Official, International or Candidate	1 FEI List or Senior Level National
CAN (Qualifier)	3	Any	International	International

A Judge at an event may not assume the duties of a TD or CD at that same event.

Juries are appointed by the Organising Committee; except for Championships when the FEI appoint the Jury.

Senior Level National Judges are defined as ones with at least 5 years experience. (See Annex 1, 2.1.1)

906.2.2 A Reserve Judge will be appointed for World Championships by the FEI. He will have the same authority as the Members of the Ground Jury, and will be accorded the same rights and privileges. However, he will not participate in handling objections and protests.

906.3 The Duties of the Ground Jury

906.3.1 The Duties and Responsibilities of the Ground Jury are laid down in the General Regulations.

906.3.2 Each Member of the Ground Jury has the right and the duty to Eliminate or Disqualify any Horse which, in his opinion, is lame or unable to continue the Competition in accordance with Article 902.4&5.

906.3.3 The Ground Jury is responsible for the conduct of the entire Event.

906.3.4 The President of the Ground Jury will have overall control of the Duties and Responsibilities of the Ground Jury throughout the Event

906.3.5 All the members of the Ground Jury will judge Competition A. Normally the Ground Jury should not judge more than 45 Competitors in a day; however this number may be increased in exceptional circumstances, at the sole discretion of the President of the Ground Jury.

906.3.6 The President of the Ground Jury is responsible for the control and publication of the results of the Competitions and of the Event.

906.4 Conflict of Interest

906.4.1 FEI Judges may not officiate at FEI Events and also compete in FEI Events in the same classes on the same continent within the same calendar year.

906.4.2 No person may be an official at an event if his duties will involve a conflict of interest.

Rules for International Combined Driving Events

- 906.4.3 The following persons may not be members of a Ground Jury or an Appeal Committee or Officials at an Event:
- 906.4.3.1 Competitors and Owners of Horses taking part in the Event.
 - 906.4.3.2 Chefs d'Equipe, Team Officials, regular trainers, employers and employees of Competitors. Note: Regular Trainers means: training a Horse/ Competitor for more than three days in the six month period before an Event, or any training during a period of three months before an Event.
 - 906.4.3.3 Close relatives of Owners, Competitors, Chefs d'Equipe or Team Officials.
 - 906.4.3.4 Persons having a financial or personal interest in a Horse or Competitor taking part in a Competition.
 - 906.4.3.5 Any other O.C. official associated with the event.
A TD at an event may not assume the duties of a Judge or CD.

Article 907 TECHNICAL DELEGATE

907.1 Appointment

There must be a Technical Delegate whenever an Event includes Competition B and/ or Competition C.

907.2 Selection

- 907.2.1 Championship. The FEI Driving Committee will appoint a Foreign Technical Delegate selected from the List of Official International Technical Delegates.
- 907.2.2 CAIO and CAI-A. The Organising Committee will appoint a Technical Delegate, selected from the List of Official International, or International Technical Delegates. For CAIO Events the Technical Delegate must be foreign.
CAI-B. The Organising Committee will appoint a Technical Delegate selected from the Lists of Official International, International or International Candidate Technical Delegates.

907.3 Duties and Responsibilities

- 907.3.1 At Championship and CAIO events he will be required to approve all administrative arrangements. From the time he is appointed until the end of the Event.
- 907.3.2 To satisfy himself that the accommodation and catering arrangements for Horses, Competitors and Grooms, and training and exercise areas, are adequate and suitable in all respects.
- 907.3.3 Inspection of the Arenas and Courses to ensure that the technical facilities, requirements and organisation are in accordance with the FEI Combined Driving Rules and associated Regulations.
- 907.3.4 To ensure that the Courses and Obstacles are fair and safe and that knowledge of local conditions does not give an advantage to Competitors from the Host Nation.
- 907.3.5 To instruct the Organising Committee and Course Designer to make any alterations which he considers necessary.
- 907.3.6 To ensure that Time Keepers, Ground Observers, Obstacle Judges and Scorers are correctly instructed in their duties, including the use and reading of chronometers and stop- watches.
- 907.3.7 To report to the President of the Ground Jury that the relevant Course is ready for the start of the Competition.
- 907.3.8 To continue to supervise the technical conduct of the Event, including the transfer of data to the Scorers, after the President of the Ground Jury has assumed control of the Event.

907.4 Assistant Technical Delegates

- 907.4.1 For World Championships the Assistant Technical Delegate may be from the Host Country and must hold at least the status of International Candidate Technical Delegate.
- 907.4.2 If appointed for CAI and CAIO events, the Assistant Technical Delegate may be from the Host Country and must have a minimum of 5 years experience in that capacity, having fully complied with the conditions laid down in Annex 3.2.
- 907.4.3 For Championships an Assistant Technical Delegate must be appointed and the Organising Committee is responsible for the Assistant Technical Delegates expenses.

Rules for International Combined Driving Events

907.4.4 The appointment of an Assistant Technical Delegate is optional for CAI and CAIO Event, if appointed the Organising Committee is responsible for the Assistant Technical Delegate's Expenses.

907.5 Conflict of Interest

See Art 906.4.2./4.3./ 4.3.1 / 4.3.2 / 4.3.3 / 4.3.4

Article 908 VETERINARY DELEGATE/ VETERINARY COMMISSION

908.1 Championship and CAIO

The composition of the Veterinary Commission, which is compulsory for Championship and CAIO events, and the appointment of its President and Members must be in accordance with the current Veterinary Regulation.

908.2 CAI-A and CAI-B

The Organising Committee must appoint a Veterinary Delegate selected from the List of Event Veterinarians in accordance with the Veterinary Regulations.

Article 909 STABLE SECURITY

909.1 Championship, CAIO

See Veterinary Regulations.

909.2 CAI- A and CAI- B

Central stable areas are not required, but the Organising Committee is responsible for the control of all stable areas so that the following minimum security requirements are met:

909.2.1 The Welfare of the Horse is the first priority.

909.2.2 Security and supervision of the Stable Area(s) must be maintained whenever any stables are occupied.

909.2.3 Security fences are not obligatory, but fences and gates may be installed for safety and security reasons at the discretion the Organising Committee.

909.2.4 The stabling area must be approved by the Technical Delegate in conjunction with the FEI Chief Driving Steward taking into account Art 909 2.1 and 2.3.

Article 910 COURSE DESIGNER

910.1 Appointment

At World Championship Events a Course Designer from the list of FEI Official International Course Designers is appointed by the Organising Committee and the Host Federation after prior approval by the FEI Driving Committee. (See Gen Regs)

910.2 Selection

910.2.1 At Championships, the Course Designer must be selected from the list of Official International Course Designers. At CAIO and CAI-A Events, the Course Designer must be selected from the List of Official International or International Course Designers.

910.2.2 At CAI-B events: The Course Designer must be selected from the Lists of Official International, International, or International Candidate Course Designers.

910.2.3 The Course Designer may be the same person for each Competition, or there may be a different Course Designer for each Competition.

910.2.4 The names, or names of the Course Designer(s) must be published in the Schedule for the Event.

910.2.5 Only the Course Designer and his staff may alter or work on any part of the Driven Dressage Arena, the Marathon and Obstacle Cone Driving Course. Any Competitor, or persons associated with a Competitor, who tamper with any part of the Arena or Courses will entail Disqualification of that Competitor.

910.3 Duties

910.3.1 The Course Designer is responsible, under the supervision of the Technical Delegate, for:

910.3.1.1 Laying out and measuring the Arena for Competition A

910.3.1.2 Laying out and measuring the Course and for the construction of the Obstacles in Competition B.

Rules for International Combined Driving Events

- 910.3.1.3 Designing, laying out and measuring the Obstacle Cone Driving Course in Competition C.
- 910.3.2 The President of the Ground Jury may only order the Competition to start when the Technical Delegate has reported that the relevant Course is ready.

910.4 Conflict of Interest

See Art 906.4.2./4.3./ 4.3.1 / 4.3.2 / 4.3.3 / 4.3.4

Article 911 FEI CHIEF DRIVING STEWARD

911.1 Appointment

- 911.1.1 At all Championships the FEI will appoint a Chief Driving Steward, selected from those on the list of FEI Stewards who have not been resident, in the country in which the Championship is to be held.
- 911.1.2 At all other International Events the Organising Committee must appoint a FEI Chief Driving Steward, selected from the List of FEI Stewards.

911.2 Duties

- 911.2.1 Driving Stewards are responsible for:
 - 911.2.1.1 Checking and measuring all the Vehicles after Competition A and C. At the Start of Section E in Competition B, and if necessary at the end of section E.
 - 911.2.1.2 Checking the bit of every Horse after Competitions A and C, and before and after Competition B. Unacceptable bits must be reported to the President of Jury.
 - 911.2.1.3 Checking that Competitors comply with the Rules pertaining to Advertising.
 - 911.2.1.4 Reporting to the President of the Ground Jury any contravention of the Rules pertaining to Vehicles, lamps, tyres, harness, bits or Advertising.
 - 911.2.1.5 Other duties as specified in the General Regulations.
Stewards, or any other Official, must report any incident of cruelty to the President of the Ground Jury as soon as possible.
- 911.2.2 The Chief Driving Steward must be clearly identifiable throughout the whole Event.

911.3 Conflict of Interest

See Art 906 4.2 / 4. 3 / 4.3.1 / 4.3.2 / 4.3.3 / 4.3.4

Article 912 APPEAL COMMITTEE

912.1 Composition

- 912.1.1 An Appeal Committee consisting of a President and at least two other Members must be appointed for all Championships and CAIOs. For CAI- A events the Appeal Committee may, at the discretion of the Organiser, only consist of the President. For CAI- B Events, the appointment of an Appeal Committee is optional. The above should be in accordance with General Regulations.
- 912.1.2 At Championship and CAIO events the President or one Member must be foreign.
- 912.1.3 The Veterinary Delegate must be in attendance in an advisory capacity for all cases involving veterinary matters including alleged cruelty to the Horse.

912.2 Appointment

- 912.2.1 World Championships at the World Equestrian Games. The Bureau of the FEI will appoint the President and members of the Appeal Committee. At all other World Championships, the FEI Driving Committee will appoint the President. The Organising Committee will appoint the other members.
- 912.2.2 All other Championships and International Events. The Organising Committee will appoint the members with the approval of the National Federation.

912.3 Qualifications

- 912.3.1 The President and the Members of the Appeal Committee must be technically qualified and must be chosen in accordance with the General Regulations, from among the following:
 - 912.3.1.1 Members of the FEI Driving Committee.
 - 912.3.1.2 Persons on any of the FEI Lists of Officials, active or retired Judges, Chief Stewards, Technical Delegates, Course Designers and Event Veterinarians.
 - 912.3.1.3 Senior Level National Judges, as defined in Annex1, 2.1.1.

Rules for International Combined Driving Events

- 912.3.1.4 For Championships and CAIO events, at least one Member must be or have been an accredited FEI Judge.
- 912.3.1.5 For CAI-A and CAI-B Events, names on the list of current or retired Senior Level National Judges, as defined in Annex 1. 2.1.1..
- 912.3.1.6 Senior Officers of the National Federation of the host nation.

912.4 Meetings

- 912.4.1 Appeals must be heard by all the Members sitting together. The President will decide the time and place of the Meeting.
- 912.4.2 The Committee must hear both sides of the case in appeals against decisions by individual Judges and Officials, and in cases referred to it by the Ground Jury in accordance with General Regulations.

912.5 Decisions

The decisions of the Appeal Committee are final, except in cases where monetary penalties have been awarded.

912.6 Conflict of Interest

See Art 906.4.2./4.3,/ 4.3.1 / 4.3.2 / 4.3.3 / 4.3.4

Article 913 CONDITIONS FOR PARTICIPATION At the Event, and Driving within the Event Location.

913.1 Minimum Age of Drivers and Grooms

Class	Driver Minimum Age
Horses Four- in- Hand, Tandem	18 years
Horse Pairs	16 years
Horse Single	16 years
All Pony Classes	14 years

- 913.1.2 Drivers under the age of 18 years must be accompanied by a groom(s) of 18 years and older.
- 913.1.3 Drivers over the age of 18 must be accompanied by a groom(s) of 14 years and over.
- 913.1.4 Age is determined from the beginning of the calendar year in which the Driver and grooms reach the designated age.
- 913.1.5 Failure to comply with any part of this Article entails Disqualification of the Competitor.

913.2 Advertising in Competitions A and C

- 913.2.1 The name of the harness-maker may appear once on each harness on a label no wider than the strap on which it appears and not longer than 10 cm.
- 913.2.2 The name of the vehicle-maker may appear on a vehicle on a label of not more than 50 sq. cm.
- 913.2.3 Identification of clothing manufacturers may appear only once per item on a surface area not exceeding 3 sq. cm.
- 913.2.4 Whilst present in the Competition Arena: the name and/ or logo of the individual's sponsor(s) and team sponsor(s) may appear on the surface area not exceeding 80 sq. cm only once on jackets or top garments at the height of the breast pockets of Competitors.
- 913.2.5 Whilst present in the Competition Arena: the name and/ or logo of the individual's sponsor(s) and team sponsor(s) may appear on a surface area not exceeding 16 sq.cm on both sides of the Competitor's shirt collar.

Rules for International Combined Driving Events

913.2.6 The sponsor's name or "logo", or the Competitor's "association", may appear on each side of the vehicle within a surface area no greater than 400 sq. cm.

913.3 Advertising in Competition B

913.3.1 Advertising is allowed on Vehicles and all clothing. The name of the harness-maker may appear once on each harness on a label no wider than the strap on which it appears and no longer than 10cms.

913.4 Penalties

Contravening any of the above advertising articles incurs 20 penalties.

Article 914 HORSES

914.1 Age

914.1.1 Single Horses must be at least 6 years for all Events.

914.1.2 All other Horses at CAI Events must be at least 5 years old.

914.1.3 All Horses at CAIO and Championships must be at least 6 years old.

914.2 Height

Driving Ponies must not exceed 148 cm without shoes, or 149 cm with shoes. All Driving Horses over these heights are classified as Horses. Driving Ponies in Pairs and Four in Hands may not be less than 108 cm without shoes, or 109 cm with shoes. Single Ponies and Tandems must not be less than 120cms without shoes, 121cms with shoes.

It is the responsibility of the competitors' National Federation to ensure that ponies competing comply with the above criteria.

914.3 Number

914.3.1 The correct number of horses stipulated for each class must be driven throughout each Competition. Competitors may not remove one or more Horses during a Competition and continue with less than the number stipulated for their Class.

914.3.2 A Horse may only take part once in each Competition.

914.3.3 Failure to comply with either paragraph 3.1 or 3.2 incurs Disqualification.

914.4 Special Conditions

(See Veterinary Regs. 1011. 2. 6. 3 – 2.6.5)

Mares are not allowed to compete after their fourth month of pregnancy or with a foal at foot. If it is subsequently confirmed that a mare competed under either of these conditions, she will be Disqualified from all Events to which these conditions applied and the Person responsible will be referred to the Secretary General for attention of the Judicial Committee.

Article 915 PASSPORTS

All Horses entered for any Competition at a CAI-B in a foreign country, and all Horses entered for CAI-A, CAIO or Championship, whether at home or in foreign countries must have an official FEI Passport, or a National Passport approved by the FEI, accompanied by an FEI Recognition Card as a means of identification and to establish ownership. (see General Regulations)

Horses taking part in a CAI-B in their own country are not required to have such a Passport as mentioned above. All such Horses must be properly registered and identifiable by diagram.

Article 916 IDENTIFICATION NUMBER

916.1 Horse

Horses must be issued with an Identification Number on arrival at an Event. This number must be attached to the left side of the Horse (Pairs and Fours should have them, visible, on the outside when in harness) at all times within the Event Location, when it is outside its stable.

916.2 Competitor

Competitors will be allocated an Event Number on arrival and will retain that number throughout the Event. The number must be displayed on any Vehicle used during the Competitions and also while schooling or exercising.

Rules for International Combined Driving Events

916.3 Penalties

Failure to display the Event Numbers of Competitors or the identification numbers of Horses will incur a warning for the first occurrence. A repeated offence will incur a Yellow Warning Card imposed by the President of Jury or the Chief Driving Steward.

Article 917 PARTICIPATION

917.1 Method of Driving

Competitors may use any method or style of Driving.

917.2 The Competitor and Grooms

917.2.1 Each Competitor must drive the same Horse(s) in all the Competitions, except if legally substituted. Art 921

917.2.2 A Competitor or Groom may not participate in Competition B more than once at any Event. Art 940.1.1

917.2.3 Groom(s) may participate with more than one Competitor in Competitions A and C.

917.2.4 The Competitor is the only person permitted to handle the Reins, Whip and Brake throughout each Competition. Each contravention of this Rule, even if to prevent an accident, will entail 20 penalties. However, a Groom may handle the Reins and Brake without penalty in all Competitions provided the Vehicle remains stationary. Exceptions see Art 926.3.5.

917.2.5 No person may be tied to the Vehicle in any way during the Competitions. A Competitor may be secured by rope, webbing or belt, provided one end is held by a Groom and not wrapped or fastened to the Vehicle in any way. Failure to comply will result in Elimination.

917.2.6 Substitution of a groom between the Start and Finish of Section E is not permitted under any circumstances, and will incur Elimination of the Competitor.

917.2.7 In Competition A and C, Competitors will be required to salute the Jury, unless time or layout of the Course prevents it.

917.2.8 Passengers may not ride on the vehicle during Competitions A, B or C.

917.3 Whip for Competitions A and C

917.3.1 The Competitor must carry a whip of traditional style. The lash, which may be tied to the stick, must be capable of release, and must be long enough to reach all the Horses.

917.3.2 A Competitor must enter the arena with a whip in hand or incur 10 penalty points.

917.3.3 If a Competitor drops or puts down his whip, when in the arena, or if it is not held in the hand, he will incur 10 penalty points.

917.3.4 The whip, if dropped, need not be replaced and the Competitor may finish without a whip. However the groom may hand the driver a spare whip and there will be no further penalty.

917.4 Whip for Competition B

The whip can only be used by the Competitor (Driver). Failure to comply will incur 20 penalties.

917.5 Dress in Competition A & C

917.5.1 The dress of Competitors and Grooms must conform to the style of the Vehicle and harness used.

917.5.2 Jackets or national dress, driving aprons, hats and gloves are obligatory for Competitors.

917.5.3 Grooms must wear jackets or national dress, hats and gloves.

917.5.4 The President of the Ground Jury may decide that:

917.5.4.1 Jackets may be removed in excessively hot and humid weather;

917.5.4.2 Jackets are not required in special circumstances;

917.5.4.3 Wet weather clothing may be worn and aprons not required in extremely wet weather.

917.5.5 Penalties for improper dress are stated under Articles 937 & 957.

917.6 Dress in Competition B

917.6.1 Less formal dress is acceptable in Competition B for the Competitor and Grooms: shorts are not permitted; Infringement will incur 10 penalties per person.

917.6.2 Competitors and Grooms must wear securely fastened protective head gear and back protectors on Section E. Infringement will incur Elimination.

Rules for International Combined Driving Events

917.7 Hors Concours

No Competitor may take part "Hors Concours" in any International Competition.

Article 918 VEHICLES

918.1 Weights and Dimensions

918.1.1 For Competitions A and C Vehicles must comply with the following:

Class	Wheels	Grooms	Min. Width
Horse Four-in-Hand	4	2 behind	158 cm
Pony Four-in-Hand			138 cm
Horse Pair	4	1 behind	148 cm
Pony Pair			138 cm
Horse Tandem	2 or 4	1 behind or beside	138 cm
Pony Tandem			
Horse Single	2 or 4	1 behind or beside	138 cm
Pony Single			

918.1.2 For Competition B the Marathon Vehicles must comply with the following:

Class	Wheels	Min Weight	Grooms	Min. Width
Horse Four-in-Hand	4	600 kg	2 behind	125 cm
Pony Four-in-Hand		300 kg		
Horse Pair	4	350 kg	1 behind	125 cm
Pony Pair		225 kg		
Horse Tandem	2 or 4	150 kg	1 behind or beside	125 cm
Pony Tandem		90 kg		
Horse Single	4	150 kg	1 behind	125 cm
Pony Single		90 kg		

918.1.3 In all Classes, if the Vehicle has no brakes, breeching is compulsory. Failure to comply 10 Penalties.

918.1.4 No part of a Vehicle may be wider than the outside Track Width, with the exception of Hub Caps and the Splinter Bar.

918.1.5 The Track Width of all Vehicles is measured at ground level on the widest part of the rear wheels.

918.1.6 The same Vehicle must be used for Competition A and C.

918.1.7 Artificial extensions to increase the measured width of a Vehicle are not permitted in Competition C

918.1.8 The President of the Ground Jury will decide whether all, or a random selection, of Vehicles will be weighed after Competition B.

918.1.9 All Vehicles will be measured before the start of section E, Competition B.

918.1.10 Competitors whose Vehicles do not conform to the required weights or measurements will be Eliminated from the relevant Competition.

918.1.11 In Competitions A & C if the Vehicle overturns the penalty will be Elimination.

918.2 Equipment

Vehicles used in Competitions A and C must be fitted with forward facing lamps and rear lamps or reflectors (penalties as per incorrect presentation). Art. 937.1.6 & 957.

918.3 Tyres

Pneumatic or air-filled, tyres are not permitted. Vehicles must be fitted with iron or solid rubber tyres. The outer surface of the tyre must be smooth. Failure to comply entails Elimination.

Rules for International Combined Driving Events

Article 919 HARNESSES

919.1 General

919.1.1 It is not necessary to use the same harness for Competitions A and C, but in both Competitions, it must be safe, clean and uniform in appearance and in a style appropriate to the turnout.

919.1.2 The Horses must be properly harnessed to the Vehicle, including the Reins.

919.1.3 Bits do not need to be identical.

919.2 Bandages and Brushing Boots

919.2.1 Bandages and Brushing Boots are not permitted in Competition A. Failure to comply entails 10 penalty points.

919.2.2 If a penalty is applied under 2.1 above, the Bandages or Brushing Boots must be removed immediately after leaving the Arena and the Horse(s) inspected by a Vet or an FEI Steward who will report his findings to the President of Jury.

919.3 Connecting Straps.

Connecting straps between neck or breast collars may be used in all Competitions. The leaders of a Four-in-Hand may not be attached to each other in any other way (except by the Reins).

919.4 Auxiliary Reins

Auxiliary Reins (including any type of check reins) are not permitted when in harness.

919.5 Tails

Tails may not be tied or attached to any part of the harness or vehicle, with the exception of a recognised tail guard. No other ancillary device which restricts the free movement of the horse's tail is permitted.

919.6. Leverage Devices

All rings, terrets and/ or other devices which have an extreme leverage effect on the reins or bits are forbidden at any time within the Driving Event Location.

919.7 Bits

Bitless bridles (hackamores) are not permitted when the Horse is harnessed to a vehicle

919.8 Tongues

Tongue straps or guards on the bit are not permitted and the tongue may not be tied in any manner (see Vet Regs).

919.9 Impaired Vision

No attachment or ancillary harness is permitted to be positioned between the wheelers and the leaders, in such a way as to impair the vision of either of the wheelers.

919.10 Application or Use of Devices, Substances or Implements

An attachment to the pole, traces or shafts, application or use of any substance, device, or implement, which may cause irritation or discomfort to the Horse is forbidden within the Driving Event Location.

919.11 Penalties

Contravention of any paragraph in this Article during Competition A, B and C will incur Elimination of the Competitor. Exception: see Art 919. 2

Contravention at any other time, within the Driving Event Location , with the exception of Art 919.2; either a verbal warning or a Yellow Warning Card will be given. For a second offence at the same event, The Jury will decide the Penalty, up to and including Disqualification.

Article 920 SHOES

Any conventional type of shoe is permitted.

Lost, damaged or spread shoes may be re-placed during Competition B, but no time allowance will be given.

Article 921 SUBSTITUTIONS

921.1 Substitutions before an Event

921.1.1 In the event of an accident or an illness to either a Competitor or to a Horse before the Event, substitutions may be made, with the following conditions, provided the Organising Committee gives its approval before the start of the Event (as defined in Art. 903.1)

Rules for International Combined Driving Events

- 921.1.2 The Competitor produces a certificate from an officially recognized Doctor/ Veterinarian to the effect that the Competitor/ Horse is not fit to compete, or the Veterinary Commission/ Delegate advise, and the Ground Jury concurs, that a Horse is not fit to take part.
- 921.1.3 A Horse or Competitor, or a combination of Horse and Competitor may only be replaced by a Horse and/or Competitor in the same class from the Nominated Entry List. Exceptions see Art 905.6.5. and 921.2.4.

921.2 Substitutions during an Event

- 921.2.1 Substitution of Horses or Competitor during a Competition is not permitted the penalty will be Disqualification.
- 921.2.2 Competitors in Four- in- Hand classes may start each Competition with any 4 of their 5 declared entries.
- 921.2.3 Competitors in Pair and Tandem classes may start each Competition with any 2 of their 3 declared entries.
- 921.2.4 Competitors in Single classes are not permitted to make any substitutions, except where the Event includes classification for National Teams at Championships and CAIOs (see Art 905.6.5 905.7.4), when only one substitution per team may be made not later than 1 hour before the start of Competition A.

Article 922 DECLARATION OF STARTERS

922.1 Declaration of Starting Horses

- 922.1.1 Chefs d' Equipe must declare the Entries for the Official Team Competition and the names of Individual Competitors, by the time laid down by the OC in accordance with the Rules. See Gen Regs.
- 922.1.2 Chefs d'Equipe (At CAIs- the Competitors) must declare in writing at least one hour before the scheduled start time of the Competition the names of the Competitors' Horses, chosen from those already definitely entered and approved at the First Inspection, who will be starting in each Competition.
- 922.1.3 At all CAI Events additional Horses may be brought to the Driving Event Location at the discretion of the Organising Committee, provided they can be properly identified by an identifying coloured number which must be attached to the harness at all times when the horse is out of the stable. The horses must comply with all the Veterinary Regulations. The additional Horse must be presented and identified at the First Inspection, where the FEI Chief Driving Steward, will also paint one hoof in a distinctive colour and ensure that the paint mark remains visible throughout the Event.

Article 923 ORDER OF STARTING

923.1 Competitions for Individual Entries at CAI

- 923.1.1 The Entry Numbers of all starters will be placed in one receptacle and the numbers of the starting positions in another. A draw will be made to determine the order of starting by drawing an Entry number and then a starting number.
- 923.1.2 An order of starting may be drawn by random computer generation, at the discretion of the Organising Committee.

923.2 Draw for CAIOs & Championships

- 923.2.1 Draw for starting positions of Individual Competitors in Driven Dressage
- Draw Competitors' name
 - Draw Position (President of Jury or Foreign Judge to Draw).
 - Enter name in Starting Order this is then repeated for all Individual Competitors.
- 923.2.2 Draw for order of Nations with Teams.
- Draw Nation.
 - Chef d'Equipe draws Position of Nation.
 - Nation position entered.
 - Chef d'Equipe names first Team Member.
 - Chef d'Equipe then draws for position A, B or C.
 - Competitors Name is entered in appropriate position.
 - This is then repeated for remaining Team Members.
 - Procedure is then repeated for All Nations.

Rules for International Combined Driving Events

- 923.2.3 Nations are then put into numerical order.
Enter Team Competitors in Starting Order Dressage.
a) Competitor A of Nation 1 is entered in first free starting position.
b) Competitor A of Nation 2 is entered into next free position.
Repeated for all remaining Nations.
a) Competitor B of Nation 1 is entered into next free position.
b) Competitor B of Nation 2 is entered into next free position.
Repeated for all remaining Nations.
Then repeated for Competitor C.
Starting Order for Driven Dressage Complete.
- 923.2.4 Determine split for Marathon.
The Individual Competitors and the positions for each official Team Member in the second half of Competition A will start first in Competition B (refer to 923.2.3 above). If there is an uneven number of Competitors the groups will be divided in such a manner that there will be one more Competitor in the first group to start in Competition A.
Example 1: Driven Dressage 1-2-3-4-5.> Marathon 4-5-1-2-3
Example 2: Driven Dressage 1-2-3-4.>Marathon 3-4-1-2
Position of Team Members in Starting Order Marathon.
Chefs d'Equipe of Teams may exchange Competitors' positions within their Team, following the drawn order of National Teams.
Teams with two competitors may not move to an empty position.
Marathon Starting Order Complete.
- 923.2.5 Order of start for Competition C
The order of starting will be:-
a) Retired Competitors, followed by,
b) Eliminated Competitors, followed by:
c) The remaining Competitors, commencing with the one with the highest number of penalties after Competitions A and B, so that the Competitor with the least number of penalties achieved without Retirement or Elimination will start last.
- 923.2.6 In the Event of Competitors having equal scores, the procedure in Article 925.3 will apply.

Article 924 EXAMINATION AND INSPECTIONS

Reference: Veterinary Regulations.

924.1 First Examination.

- 924.1.1 This must take place at all Events upon arrival of competing Horses, and in any case before they enter the Event stables.
- 924.1.2 The purpose of this First Examination is to establish the Horses' identity by checking the Passport and any other relevant documents, and to establish its general state of health.
- 924.1.3 The First Examination must be performed by the Veterinary Delegate or a Treating Veterinarian of the host country.
- 924.1.4 Any doubtful cases concerning identity or health must be reported to the Veterinary Delegate (if he does not perform the First Examination himself) or to the Veterinary Commission as soon as possible and in any case no later than one hour before the First Inspection.

924.2 First Inspection

- 924.2.1 This must take place at all Events before the start of Competition A. It must be performed under the direction of the President of the Ground Jury, together with at least one other Member of the Ground Jury, the Veterinary Delegate and/or the President of the Veterinary Commission. See Veterinary Regulations and Guidelines for Organizers and Officials for details.
- 924.2.2 For safety reasons, Horses must be presented in bridles and shown on a loose rein or lead. Each horse must display its identity number (Art 916.1).
- 924.2.3 Horses are not permitted to wear bandages or rugs.

Rules for International Combined Driving Events

- 924.2.4 No Horse may be presented with its identity concealed in any manner by application of paint or dye.
- 924.2.5 One FEI Driving Steward with a Whip must be present. He is the only person who may assist if a Horse refuses to trot. Handlers may not carry a Whip while showing the Horse. The use of a short whip for restraint of stallions and difficult Horses may be allowed by the Inspection Panel upon request (See Veterinary Regulations)
- 924.2.6 The Inspection consists of an initial observation of the Horse standing still. It must then be walked in front of the Inspecting Committee, and then trotted 30 meters away from the Committee before returning towards the Committee at the trot.
- 924.2.7 A Veterinarian may be allowed to handle a limb or other parts of the body, but he may not perform any other clinical tests (i. e., flex a limb, or walk or trot a Horse in a circle;(see Veterinary Regulations).
- 924.2.8 In exceptional or doubtful cases, the Inspecting Committee may direct that a Horse be placed in an officially supervised holding area for a further inspection to take place at a convenient time during the Inspection.
- 924.2.9 In exceptional cases, any Horse, which is required to be re-inspected on the following day and passes the re-inspection, must be sampled for forbidden substances before it is allowed to take part in Competition A. The Competitor will be required to pay the cost of the test as laid down by the OC. This must be paid to the OC before starting Competition A.
- 924.2.10 Only a member of the Ground Jury has the authority to Disqualify any Horse which is considered to be unfit for the Event (marked lameness, serious injury or poor general condition). A Veterinarian has no authority to disqualify a Horse.
- 924.2.11 In all cases of further inspection resulting from 2.8 above or re-inspection on the following day resulting from 2.9 above each Member of the Ground Jury and the Veterinary Delegate will be issued with a Voting Slip on which they must indicate with an x either Yes or No as to whether they consider the Horse fit to compete. These forms will be handed to the President of Jury who will announce the majority decision as to whether the Horse may compete. When there are two lanes of horses being inspected the whole Jury will come together along with the chief Veterinary officer from each lane. The President of Jury will, at all times, have the casting vote if there is a tie in the voting. There is no Appeal against this decision.
- 924.3 Second Inspection
- 924.3.1 This must take place at all Events during, and at the site of, the 10 minute Compulsory Rest prior to the Start of Section E in Competition B. One Member of the Ground Jury and a Veterinarian are responsible for this Inspection. It must be performed carefully but rapidly so that the Competitor has time to care for his Horses before the start of Section E.
- 924.3.2 The fitness of the Horses must be determined by clinical observation, which may include: measuring the heart rate, the respiratory rate and the temperature in accordance with the Veterinary Regulations. These observations must be recorded.
- 924.3.3 The Ground Jury member must Eliminate the Competitor if his Horse is considered to be lame, injured or obviously exhausted and unfit to continue the Competition.
- 924.4 Second Examination**
- The Second Examination must take place at the finish of Section E of Competition B at all Events. It must be performed under the supervision of a Treating Veterinarian in case any Horse needs immediate treatment. The Veterinarian has no authority to Disqualify a Horse. He must report his findings to the Veterinary Delegate and President of Jury as soon as possible after the last Competitor has completed Competition B.
- 924.5 Final Observation before Competition C**
- 924.5.1 The Final warm-up Observation must be carried out before any Horse starts Competition C. It must be performed by an Inspecting Committee consisting of one Member of the Ground Jury together with the Veterinary Delegate, or the Veterinary Commission. The Final warm- up Observation is obligatory at all Events. If a Horse which is competing in Competition C is not presented, it will be Eliminated, and the Competitor given a Warning Yellow Card.
- 924.5.2 Horses will be inspected harnessed to their Vehicles. Leg bandages over-reach boots and brushing boots are permitted, but must be removed if required by a member of the Veterinary Commission.

Rules for International Combined Driving Events

924.5.3 Only the Ground Jury Member has the authority to disqualify the Horse if considered to be unfit to continue the Event.

924.6 Removing a Horse from Competition

924.6.1 Each member of the Ground Jury has the right and duty to eliminate any Horse at any time, during Competition B, which is evidently lame, injured or unfit to continue. No Appeal may be made against a decision taken under the terms of this Article.

924.6.2 The Technical Delegate may stop a Competitor, if, in his opinion, the Horse is unfit to continue the Competition, a hold up time will be recorded, pending confirmation by a member of the Ground Jury.

924.6.3 The Competitor may Retire at any time. Art 902.6.

924.7 Medication Control

This must be conducted in accordance with General Regulations, and the Veterinary Regulations.

Article 925 CLASSIFICATION

925.1 Competitions

925.1.1 At the conclusion of each Competition, the Competitors will be classified according to the penalties received in that Competition.

925.1.2 The Competitor with the least number of penalties in each Competition is the winner of the respective Competition.

925.1.3 Scores will be calculated to two decimal places.

925.2 Events

925.2.1 The Final Classification for individuals is determined by adding together the penalties received in each Competition. The Competitor with the lowest number of penalties is the winner of the Event.

925.2.2 Competitors who are Eliminated, Disqualified, Retire, or Withdraw in any one of the Competitions cannot be included in the Final Classification. They will only be listed on the result sheet as having been: Eliminated (E), Disqualified (D), Retired (R), or Withdrawn (W).

925.3 Equality of Scores

If there is an equality of scores on completion of the three Competitions, the Competitor with the least number of penalties in Competition B will be classified above the others. If there is still an equality of points, the scores in Competition A will be the deciding factor.

925.4 Team Classification

This is determined by adding together the scores of the two Competitors in each National Team with the lowest penalties in each Competition. Only the scores of those Team Members who have completed all three Competitions can be counted towards the final team scores.

925.5 Combined Championships

925.5.1 One or two Singles, one or two Pairs and one or two Four- in-hand will form a Team.

925.5.2 The Team classification will be determined by adding together the scores of the best Team Competitor in each Competition for Single, Pair and Four- in- Hands. Only those scores of the Team Members who have completed all three Competitions without Elimination can be counted towards the final Team scores.

925.5.3 In case of equality of scores, Article 925.3, Classification of the best Team Members of the Single, Pair and Four in Hands in Competition B will be classified above the others. If then is still an equality of points, the scores in Competition A will be decisive in determining the winner of the Event.

925.6 Names of Horses

The names of the Horse must appear on the Final Score Sheet, including the name of the Reserve Horse, if it took part in any of the Competitions.

925.7 Protests and Appeals

925.7.1 Protests. See General Regulations.

925.7.2 Appeals. See General Regulations.

925.8 Official Results

Results are "Official" as soon as they have been confirmed and signed by the President of the Ground Jury. See Gen. Regs.

Rules for International Combined Driving Events

Article 926 OUTSIDE ASSISTANCE

926.1 Definition

Any intervention by a third party, not riding on the Vehicle, whether solicited or not, with the object of facilitating the task of the Competitor or helping his Horses, is considered to be Outside Assistance.

926.2 Prohibited Outside Assistance

926.2.1 In Competition A Grooms must remain seated in their proper position between entering and leaving the Arena unless as otherwise defined within the rules. In Competition C grooms must remain seated in their proper positions between the Start and Finish line unless as otherwise defined within the rules. Failure to comply will result in elimination. See also Art 956.1.8. They are not permitted to handle the Reins, the Whip or the Brake, nor speak or indicate the Course to the Competitor. However the Groom may handle the Reins, Whip and Brake without penalty provided the Vehicle remains stationary. Exception: If the bell has been rung by the President of Jury and the Competitor has failed to hear the bell; the Groom may advise the Competitor that the bell has been rung.

926.2.2 In Competition B, to have a person at an Obstacle for the purpose of assisting a Competitor or Horses by any means whatsoever.

926.2.3 To have any person on a Vehicle during Competition B who has already been round the course on another Vehicle.

926.2.4 Obstacle Observers, Ground Observers, Time Keepers or any other Officials may not give directions, advice or information to the Competitor, while he is on the Course in Competition B, in order to assist him. Exception Art 946.7

926.2.5 Competitors and Grooms may not use any form of electronic communication equipment while competing on Course during the Competitions.

926.3 Permitted Assistance

The following are considered to be permitted outside assistance:

926.3.1 Assistance during compulsory rests and in neutral zones between Sections.

926.3.2 Assistance to avoid accidents.

926.3.3 Assistance in righting an overturned Vehicle.

926.3.4 Assistance to Horses as a result of an accident inside an obstacle, providing the Grooms are dismounted.

926.3.5 Assistance by the Groom whereby a Horse is led through an Obstacle by the bridle ends of the reins while harnessed to the vehicle in either Competition B or Competition C, will incur 20 penalties for the assistance, but no further penalties for the groom dismounting.

926.4. Penalty

926.4.1 The circumstances of each incident must be assessed by the Ground Jury after seeking the opinion of any responsible Official having knowledge of the incident.

926.4.2 Any Competitor who has received Prohibited Outside Assistance will be Eliminated by the Ground Jury.

Article 927 CRUELTY

927.1 Definition

Excessive pressing of exhausted Horses, excessive use of a whip, an unacceptably severe, badly fitting, broken or damaged bit; badly fitting harness which might cause distress to the horse, damage to a vehicle which might cause injury to the Horse; or any other action, which, in the opinion of the Ground Jury, is clearly and unmistakably an act of cruelty.

927.2 Reporting

Stewards, or any other Official, must report any instance of cruelty to the President of the Ground Jury as soon as possible.

927.3 Penalty

Any act that can be clearly defined as Cruelty, in the opinion of the Ground Jury, will be penalised by Disqualification from the Event.

Rules for International Combined Driving Events

Article 928 TRAVEL, EXPENSES AND ACCOMMODATIONS

928.1 Expenses and privileges

Expenses and privileges are laid down in General Regulations.

928.2 Meals, Accommodation

The Organising Committee is responsible for the Travel Expenses meals and accommodations of the Ground Jury, Appeal Committee, the Veterinary Commission, the Technical Delegate, the Assistant Technical Delegate, the FEI Chief Driving Steward and the Course Designer.

928.3 Transportation during the Event

If the situation necessitates, the Organising Committee must provide transportation for the President and Members of the Ground Jury, Appeal Committee, Veterinary Commission, Technical Delegate, and Course Designer.

Chapter II COMPETITION A – DRIVEN DRESSAGE

Article 929 PRINCIPLES

929.1 The Object

The object of the Driven Dressage Test, Competition A, is to judge the freedom, regularity of paces, harmony, impulsion, suppleness, lightness, ease of movement and correct bending of the Horses on the move. Competitors will also be judged on style, accuracy, and general control of their Horses, and also on their dress, condition of their harness and Vehicle and the presentation of their whole turnout.

Article 930 THE ARENA

930.1 The Arena

- 930.1.1 The Driven Dressage Arena must be 100m x 40m and laid out in accordance with the Annexes for all classes at Championship and CAIO events and for all classes of Four- in- Hand at CAI Events.
- 930.1.2 At CAI Events a smaller Arena, measuring 80m x 40m and laid out in accordance with the Annexes, may be used for all classes of Singles and Pairs, in which case the loops of the serpentine must be reduced from five to three.
- 930.1.3 Organisers must ensure that arrangements are in place to ensure that spectators cannot approach closer than 5 meters from the edge of the Arena.

Article 931 DRIVEN DRESSAGE TESTS

931.1. Approved Tests

Details of approved FEI Driven Dressage Tests are shown on the FEI Website. The Schedules for all Events must state clearly which of these Tests is to be used.

931.2 Free Style Tests

- 931.2.1 The Organising Committee may arrange a Free Style Driven Dressage Competition with or without music, provided that it is not part of the Combined Driving Event. The method of scoring must be clearly explained in the Schedule. The Judges should give one set of marks for content, another for general impression and a third for the interpretation of the music if required.
- 931.2.2 The programme selected by the Competitor should not exceed the time designated by the OC. The President of the Ground Jury must ring the bell for the first time one minute before the end of the time allowed. The bell will be rung again at the end of the time allowed to indicate that the Competitor must bring his performance to an end immediately.

931.3 Demonstration Dressage Test

- 931.3.1 At Championships and CAIO events, one Demonstration Dressage Test may be driven no later than 30 minutes before the start of Competition A.
- 931.3.2 The Technical Delegate must decide, together with the O.C., whether a Demonstration Test will be a Single, Pair or Four- in- Hand when the Event consists of more than one Class.
- 931.3.3 This requirement is optional at CAI-A and CAI-B Events.

Rules for International Combined Driving Events

Article 932 CONDITIONS

932.1 Entry

932.1.1 A Competitor who enters the Arena before the starting signal or who fails to enter the Arena within 90 seconds of the starting signal may be Eliminated, at the discretion of the President of the Ground Jury.

932.1.2 In Championships any Competitor who exceeds the published maximum score of driven penalties points in Competition A, Driven Dressage, will not be allowed to continue in Competitions B and C. see Art 905.3.2.

932.2 Memory

The Driven Dressage Test must be driven from memory.

932.3 Lameness

932.3.1 If the President of the Ground Jury observes a case of marked lameness, he must Disqualify the Horse and Eliminate the Competitor. There can be no appeal against this decision.

932.3.2 In doubtful cases, after the Competitor has finished his Test, the President of the Ground Jury may have the Horse checked immediately by the Veterinary Delegate outside the Arena while harnessed to the vehicle.

932.3.3 In Competitions where additional Dressage Arenas are being used, the references to the President of the Ground Jury in 3.1 – 3.2 above shall be responsibility of the Judge at C of the applicable Arena

932.4 Welfare .See Article 901.

932.5 Treating Veterinarian

At CAI's a Treating Veterinarian appointed by the Organising Committee must be available to the Jury, under arrangements approved by the President of Jury. At Championships and CAIO's they must always be available.

Article 933 JUDGING

933.1 Positions of Judges

When there are 5 Judges officiating in Test 8a, the President will be seated at C. 1 Judge on each side of C, 5 meters in from the long side of the Arena and the remaining Judges will be seated at B & E. When there are 3 Judges officiating, the President must be seated at C, with the remaining 2 Judges at B and E. For all other Tests the Judges may be seated at CRSVP if there are 5 Judges and CBE if there are 3 Judges.

933.2 Allocation of Marks

The Judges will allocate their marks individually and there will be no consultation among Judges once the Competitor has started the Test.

933.3 Multiple Turnouts

Pairs, Tandems and Four in Hands will be judged as a whole and not as individual Horses.

933.4 Pace

The definition of paces under Article 934 - Movements will apply to all types and breeds of Horses.

933.5 Start and Finish

The Test Starts as the Competitor enters the Arena at A, unless otherwise stated, and Finishes with the final salute. Tests are not timed. The Competitor will leave the Arena at a trot.

Article 934 MOVEMENTS

934.1 Halt

The Horse must stand square and straight with the weight evenly distributed among all four legs. The Horse must remain attentive, and motionless, ready to move off at the slightest indication from the Competitor.

Rules for International Combined Driving Events

934.2 **Walk**

A regular, unconstrained walk of moderate length. The Horse, remaining in a light contact, walks energetically, but calmly with even and determined steps with the hind feet touching the ground in front of the foot prints of the fore feet.

934.3 **Working Trot**

A forward, active trot, with the Horse on the bit, carrying himself in balance and rhythm with even, elastic steps and good hock action. The steps of the hind feet must at least be touching the ground in the footprints of the fore feet.

934.4 **Collected Trot**

The Horse remains on the bit and moves energetically forward with a greater degree of engagement, leading to an increased flexion of the hocks and fetlock joints and a lightning of the shoulders thus allowing for more mobility and elevation of the steps. The neck will be raised and more arched, with the poll the highest part, the nose should not be behind the vertical, or the neck restricted.

934.5 **Extended Trot**

The Horse lengthens his stride to cover as much ground as possible as a result of greater impulsion from the hindquarters. The Competitor allows the Horse, remaining "on the bit" without leaning on it, to lengthen its frame to gain ground, with the nose slightly in front of the vertical. The hind feet must clearly over track the prints made by the fore feet.

The Horse must remain in balance while maintaining the same rhythm with steps of equal size. Going faster is not asked for, and is a severe fault.

934.6 **Working Canter**

A forward, active pace with regular steps of three time beat. The Horse, showing good balance, remains on the bit without leaning on the hand, and goes forward with light cadenced steps and good hock action.

A Canter to the right, for instance will have the footfalls follow one another in the following sequence: left hind, left diagonal (simultaneously left fore and right hind), right fore, followed by a moment of suspension with all four feet off the ground before the next stride begins.

The quality of the Canter is judged by the general impression, and the regularity and lightness of the three-beat pace. The Horse must be on the bit and well engaged in the hindquarters with good hock action, and must have the ability to maintain his rhythm and natural balance throughout the movement and the transitions. The Horse must remain straight on straight lines and correctly bent on curved lines.

934.7 **Rein Back**

The Horse must walk backwards in a straight line, with the legs being lifted and set down in diagonal pairs. The Horse must remain on the bit, straight and not evade or resist the contact.

Transition to the next movement must be immediate and smooth.

934.8 **Shoulder In**

Shoulder in for the driven horse is performed in Collected Trot. The leaders are positioned so that the outside leader's tail is in front of the head of the pole. The leaders' shoulders are taken to the inside with a constant angle of approximately 30 degrees and a slight but consistent bend in the neck. The inside hind leg steps forward into the line of the outside front leg so that the Horses are working on three tracks. Impulsion, rhythm and engagement must be maintained throughout.

Too much bend in the neck results in loss of rhythm and suppleness. The wheelers must remain straight with no counter bend.

Rules for International Combined Driving Events

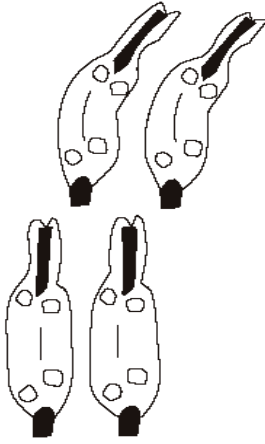

934.9 Transitions

Changes of pace must always be made smoothly and promptly with the Horse remaining in balance and on the bit. A transition must be completed as the nose of the Horse arrives at the prescribed marker, unless otherwise stated.

934.10 Change of Pace and Movement

Changes of pace and movement are made when the heads of the leaders reach the point indicated in the test.

934.11 Terminology

The following must be considered when judging Driven Dressage movements:

- 934.11.1 Obedience and Lightness – willing response to aids without resistance and correctness of bend.
- 934.11.2 Regularity – the regularity, evenness and rhythm with which the Horse puts his feet to the ground.
- 934.11.3 Contact – the tension/ connection in the reins between the Competitors hands and the Horse. It should be light and flexible and maintained at all times.
- 934.11.4 Impulsion – the willingness of the Horse to go forward energetically at all times and to respond quickly and evenly to changes of pace. The Horse must remain in balance while maintaining the same tempo with steps of equal size.
- 934.11.5 Straightness – carrying the head, neck and body in a straight line with the weight evenly divided among the legs.
- 934.11.6 Collection – roundness and engagement with good hock action, elevated poll allowing the shoulders to move with ease. The Horse's energy is contained in a more deliberate pace than the Working Trot.
The haunches are more compressed, the croup is lowered and the forehead elevated to the same degree. The stride is shorter but more powerful than the Working Trot and the front legs will move from the shoulder with greater agility resulting in lightness and greater mobility throughout. The neck should be more arched. The shortening of the frame is not and never should be a result of pulling back but rather of asking and allowing the Horse to move forward into the Competitors (Driver's) hand.
- 934.11.7 Accuracy - Accuracy of turns, circles, serpentine, along side rails, deviations.

Article 935 GENERAL IMPRESSION

935.1 Principle

There are five boxes at the end of the Judges Score Sheets for marks on General Impression.

935.2 Paces

Regularity and freedom (if Four- in- Hand, Pair or Tandem, maintenance of pace by all Horses). The quality of paces in each movement is marked under the appropriate movement. The mark for the general impression must reflect paces and transitions during the whole Test.

Rules for International Combined Driving Events

935.3 Impulsion

Moving forward, engagement of the hind quarters (if Four- in- Hand, Pair or Tandem, all Horses working). The level of impulsion may vary between movements and pace, but the mark for impulsion must reflect the performance of the Horses throughout the Test.

935.4 Obedience and Lightness

Responsive to aids, willing and without resistance. Correctness of bend. Suppleness, acceptance of the Bit.

935.5 Competitor

Use of aids, handling of reins and whip, position on the box, accuracy of figures. The mark must reflect the consistent level of accuracy and quality of transitions.

935.6 Presentation

935.6.1 Appearance of Competitor and Grooms, cleanliness, fitness, matching and condition of Horses, Vehicle and harness.

935.6.3 If the Competitor, Groom(s), Vehicle or harness do not comply with these Rules, or equipment or clothing is missing, the President of the Ground Jury will award 5 penalties per Article 937

Article 936 SCORING

936.1 Marks

Marks out of 10 will be awarded for each numbered movement and for each heading under General Impression on the following basis:

10: Excellent 4: Insufficient

9: Very Good 3: Fairly Bad

8: Good 2: Bad

7: Fairly Good 1: Very Bad

6: Satisfactory 0: Not Executed

5: Sufficient

936.2 Error of Test

If a Competitor attempts to perform a movement, or attempts to maintain the pace required, and fails to do so, but does not deviate from the track, the President of the Ground Jury may either treat it as an "Error of Course" (see paragraph 3 below), or he may decide to leave the Judges to give the movement an appropriate mark. If a Competitor makes no effort to perform a movement in a Test then it may either be treated as an Error of Test or as an Error of Course at the discretion of the President of Jury.

936.3 Error of Course

936.3.1 An "Error of Course" is when a Competitor deviates from the required track or when a movement is performed at the wrong pace, or omitted altogether.

936.3.2 In the event of a Competitor making an Error of Course, the President of the Ground Jury will ring the bell and stop the Competitor. The Competitor must then resume the Test from the beginning of the movement where the error was made. If the Competitor is in any doubt, he may ask the President of the Ground Jury for guidance, without incurring any penalties.

936.4 Disconnected or Broken Harness

If the reins, pole strap, chains or trace become disconnected or broken, or should the Horse get a leg over the pole, trace or shaft, the President of the Ground Jury must ring the bell and a Groom(s) must dismount and re-connect or repair as appropriate. The Competitor will be penalised for a Groom(s) dismounting.

936.5 Disobedience

Any resistance in the forward movement, kicking or rearing is considered to be disobedience and will be penalised by the Judge at C, as follows:-

1st Incident.....5 penalties

2nd Incident.....10 penalties

3rd Incident.....Elimination

Rules for International Combined Driving Events

Article 937 SUMMARY OF DRIVEN DRESSAGE PENALTIES

937.1 Competitors are liable to the following penalties:

937.1.1	Art. 932.1	Early or late entry	Possible Elimination
937.1.2	Art. 917.3.2	Entering the Arena without a whip	10 penalties
937.1.3	Art. 917.3.3	Dropping or putting down a whip	10 penalties
937.1.4	Art. 917.5	Incomplete presentation of Competitor	5 penalties
937.1.5	Art. 917.5	Incomplete presentation of Groom	5 penalties
937.1.6	Art. 918.2.	Incomplete presentation of vehicle	5 penalties
937.1.7	Art. 936.3	Errors of course: First occasion Second occasion Third occasion	5 penalties 10 penalties Elimination
937.1.8		Part of the turnout leaving the Arena during a movement	Mark down for inaccuracy
937.1.9		The whole turnout leaving the Arena	Elimination
937.1.10	Art. 918.1.9	Vehicle overturning	Elimination
937.1.11	Art. 926.2 & 903.3	Groom(s) dismounting First incident Second incident Third incident	5 penalties 10 penalties Elimination
937.1.12	Art. 903.3	Competitor dismounting	20 penalties
937.1.13	Art. 902.8	Lame horse	Disqualification of the Horse and elimination of the competitor
937.1.14	Art. 919.2.1	Use of bandage or brushing boots (Horse to be inspected after Test)	10 penalties
937.1.15	Art. 926.2.	Outside Assistance	Elimination
937.1.16	Art. 936.5	Disobedience: First incident Second incident Third incident	5 penalties 10 penalties Elimination
937.1.17	Art. 918.1.3	No breeching and vehicle has no brakes	10 penalties
937.1.18	Art. 913.2	Contravening the Rules on Advertising	20 penalties

Article 938 CLASSIFICATION

938.1 Total Marks

- 938.1.1 The individual marks awarded by each Judge for each movement and for General Impression will be added together and divided by the number of Judges to obtain the average score.
- 938.1.2 In order to adjust the influence of Competition A on the whole event, where the total possible marks for the Test are greater than 160, the average score will be multiplied by the coefficient printed on the score sheet to obtain the adjusted average score to be used in the results.
- 938.1.3 Penalties are only awarded by the President of the Ground Jury at C. Any penalties will be deducted from the adjusted average score (see paragraph 1.2 above) and the final total will be deducted from 160 to obtain the penalties for the Test.
- 938.1.4 Scores will be calculated to two decimal places.
- 938.1.5 The Competitor with the lowest score in penalties will be the winner of Competition A.

Rules for International Combined Driving Events

Chapter III COMPETITION B – MARATHON

Article 939 GENERAL

The object of Competition B – Marathon – is to test the fitness, stamina and training of the Horses, and the driving skill, judgment of pace and general horsemanship of the Competitor.

Article 940 COMPETITORS

940.1 Participation

- 940.1.1 A Competitor or Groom may only take part in Competition B once at the same Event.
- 940.1.2 Substitution of a Groom between the Start and Finish of Section E is not permitted under any circumstances and shall incur elimination.

940.2 Horse Welfare. See article 901.

Article 941 THE COURSE

941.1 Maximum Distances and speeds not to be exceeded

Section	Maximum Distance	Minimum Distance	Pace	Speed km/hour	
				Horse	Pony
A	8000 m	5000 m	free	15	14
D	1000 m	800 m	walk	7	6
E	9000 m	6000 m	free	14	13

These speeds may be reduced by the Technical Delegate and the President of Jury in the case of adverse weather or ground conditions.

(See Annex 6 for 5 Section criteria).

- 941.1.1 In all Competitions, the Course must consist of three Sections. (Exception see Art 904.5.) The distance must be as close to maximum distance as possible for Championships.
- 941.1.2 The total distance for all Competitions must not exceed a total length of 18 km
- 941.1.3 The total distance in Section E should be approximately one km per Obstacle. The total distance in Section E must include the distances through the Obstacles.
- 941.1.4 The distances between the end of one Section and the start of the next must not be included in the total length and time of the course.
- 941.1.5 All Championships must have eight Obstacles. All other Events shall have between six and eight Obstacles.

941.2 Compulsory Rests

- 941.2.1 There must be a Compulsory Rest of not less than 10 minutes in the designated Rest Area prior to the Start of Section E.
- 941.2.2 The area of the Compulsory Rest should, if possible, provide some shade and must be large enough to accommodate three Competitors at once and have room for additional motor vehicles.
- 941.2.3 Water must be provided at the Rest for the Horses.
- 941.2.4 A farrier must be available at the Rest after Section D.
- 941.2.5 In exceptional circumstances, the minimum time required for the Compulsory Rest may be increased at the discretion of the Ground Jury.
- 941.2.6 Competitors may only stand or walk their horses within the Rest Area.

941.3 Section and Direction Signs

- 941.3.1 The beginning and end of each Section must be marked with a pair of Red and White flags and a Start and Finish sign.
- 941.3.2 There should be approximately 50m between the Finish of one Section and the Start of the next.

Rules for International Combined Driving Events

- 941.3.3 The entire Course must be clearly marked with Yellow Direction Markers placed, wherever possible, on the right hand side of the track to be clearly visible to the approaching Competitor. A confirmation directional arrow must be placed after every significant turn.
- 941.3.4 Sections A and E must have a Marker at every kilometre. In Section E the measurement of the kilometres must include the distances through the Obstacles.
- 941.3.5 The Marker for a kilometre occurring within an Obstacle should be placed on the post supporting the Red Exit Flag.

941.4 Compulsory Turning Flags

- 941.4.1 Sufficient Red and White Compulsory Turning Flags must be positioned on the Course to ensure that all Competitors follow the designated track without deviation. Competitors must leave the Red Flags on their right and the White Flags on their left. These Compulsory Turning Flags must be numbered consecutively in each Section and they must be placed so they are clearly visible to Competitors from a reasonable distance.
- 941.4.2 The location and number of the Flags must be marked on the Map of the Course to clearly indicate the correct route to be driven between the Compulsory Turning Flags before and after each Obstacle. In addition, a list showing the order for driving Compulsory Turning Flags and Obstacles must be provided for Competitors and Officials.
- 941.4.3 Ground Observers must record the Competitor's Track through The Compulsory Turning Flags; if any Compulsory Turning Flags are missed out or passed in the wrong sequence, the details must be reported to the Ground Jury as soon as possible.

941.5 Paces

The Finish of Section E must not be less than 300 m from the exit of the last Obstacle. If the distance exceeds 500 m (which requires the agreement of the Technical Delegate) a clear sign must be placed 500 m from the Finish to indicate to Competitors that they must either Walk or Trot to the Finish without deviating from the Track. Art 945.3.

941.6 Walk Section D

Natural obstacles such as gates, sharp turns, water and steep hills should not be included in Walk Sections.

Article 942 OBSTACLES IN SECTION E

942.1 Number of Obstacles

- 942.1.1 The maximum number of Obstacles, natural or artificial, is eight. The minimum number is six.
- 942.1.2 For Championships there must be eight Obstacles.

942.2 Sketches of Obstacles

Accurate sketches of each Obstacle, showing the location of the Compulsory Gates, Dislodgeable Elements and Entry/Exit Flags must be made available to Competitors, Team and Event Officials before the first inspection of the Course. Art 943.2.4.

942.3 Design and Construction of Obstacles

- 942.3.1 The number of each Obstacle must be clearly displayed on the post supporting the Red Entry Flag.
- 942.3.2 The Entry and Exit of each Obstacle must be marked by Red and White Flags (red on the right and white on the left), not less than 20 m from the nearest lettered gate, unless the Technical Delegate grants an exception.
- 942.3.3 The track through an Obstacle should not exceed 250 m on the shortest, 2.5 m drivable route. That is; not narrower than 2.5 m at any point, between the Entry and Exit Flags. The track may exceed 250 m in exceptional circumstances, at the discretion of the Technical Delegate.
- 942.3.4 Obstacles must be at least 250 m apart.
- 942.3.5 Obstacles must be clearly numbered in the sequence in which the Competitors are required to drive them.
- 942.3.6 Obstacles must not include any feature, which might cause damage or injury to the Horses.

Rules for International Combined Driving Events

- 942.3.7 Artificial Obstacles must be solidly constructed and firmly fixed, so that they are unlikely to be moved or broken during the Competition.
- 942.3.8 If the Course Designer includes any element in an Obstacle, which in the opinion of the President of Jury or Technical Delegate could frighten the Horses, an alternative route must be provided, within the Obstacle.
- 942.3.9 Where a constructed water crossing is included in an Obstacle, the depth of the water must not be more than 30 cm. Where natural water is used the Technical Delegate may allow a maximum depth of 50 cm. The bed of any water crossing must be firm. Where water depth exceeds 50 cm a substantial fence, firmly fixed, must be constructed, to prevent Horses going into deep water.
- 942.3.10 If a barrier for crowd restraint is required, by local regulations or the Organiser, it must not be positioned closer than 20 m from the nearest element in the Obstacle, unless the Technical Delegate grants an exception.

942.4 Compulsory Gates

- 942.4.1 Obstacles may include up to six Compulsory Gates marked with Red and White letters, which should be marked A B, C etc, indicating the sequence in which they must be driven.
- 942.4.2 The height of any elements within a Compulsory Gate must not be less than 1.30 m.
- 942.4.3 No Compulsory Gate may be narrower than 2.50 m.

942.5 Dislodgeable Elements

- 942.5.1 The Course Designer is free to choose any type of Dislodgeable Element, provided it does not interfere with, or cause injury to the Horse or damage to the Vehicles, when it is dislodged.
- 942.5.2 The number of Dislodgeable Elements is at the discretion of the Course Designer, but must be approved by the Technical Delegate and the President of the Jury.
- 942.5.3 Competitors will incur 2 penalties for each Element dislodged.
- 942.5.4 A Dislodgeable Element is "live" at all times until it is dislodged.
- 942.5.5 A Competitor or Groom who attempts to prevent a dislodgeable element from being dislodged will incur 10 penalties.

Article 943 INSPECTION OF THE COURSE

943.1 Visit of the Technical Delegate

At least 5 days before Competition B, the entire Course, including the Obstacles, must be available for inspection and approval by the Technical Delegate.

943.2 Briefing for Competitors and Officials

- 943.2.1 The Technical Delegate must arrange a Briefing for Members of the Ground Jury and the Chefs d'Equipe (Competitors at CAI Events) prior to the official opening of the Course.
- 943.2.2 Ground Observers, Obstacle Observers and Time Keepers must be briefed by the Technical Delegate or his designated representative before the start of Competition B.
- 943.2.3 Copies of Maps of the entire Course must be available at the Briefing, for those requiring them. The Maps must show each Section, the location of all the Obstacles and numbered Compulsory Turning Flags, Kilometre Markers, and any areas of the Course which are closed to motor vehicles.
- 943.2.4 Drawings of the Obstacles must be available for Chefs d'Equipe, Competitors and Officials during the Briefing.
- 943.2.5 A list showing the order for driving Compulsory Turning Flags and Obstacles must also be made available.

943.3 Inspection of the Course by Competitors.

- 943.3.1 At least 48 hours before the first Competitor is due to start Competition B, the whole Course must be open for inspection by the Competitors, except under exceptional circumstances, when Organisers have the option not to open Sections A and D for inspection, with the agreement of the Technical Delegate.
- 943.3.2 The Technical Delegate may impose restrictions on the means of access to certain parts of the Course.
- 943.3.3 The course is closed for inspection from the time the first Competitor starts Section A. The Obstacles in Section E may be left open until the first Competitor starts Section E.

Rules for International Combined Driving Events

- 943.3.4. Competitors using motor-vehicles must remain on the roads and tracks designated by the Technical Delegate.
- 943.3.5 The Obstacles may only be inspected on foot. No motor vehicles or bicycles may be taken inside any part of an Obstacle. Failure to comply will be penalised by the issue of a Warning for the first infringement and a Yellow Warning Card for the second. Drivers with Disabilities must obtain a dispensation from the Organiser to be exempt from this Article and their vehicles clearly identified.
- 943.3.6 Competitors must not ride a horse, or drive any horse drawn vehicle through the Obstacles in the 30 days prior to the event in which they are competing.

Article 944 TIMES

944.1 Timetable

- 944.1.1 A Timetable showing the start of Section A and the time table of each Section, including the Compulsory Rest, must be drawn up by the Organising Committee for the Ground Jury and Technical Delegate. It must be adjusted in the event of unforeseen circumstances and redistributed.
- 944.1.2 A Timetable showing the Starting time for each Competitor on Section A must be provided to the Competitors and the Timekeeper at the Start of Section A. Running Order Lists must be provided to all other Timekeepers, Ground Observers and Obstacle Observers.

944.2 Times in Sections

- 944.2.1 The Time Allowed for each Section is calculated according to the average speed selected for that Section in accordance with Article 941.1.
- 944.2.2 The Minimum Time in Section A is two minutes less than the Time Allowed.
- 944.2.3 There is no Minimum Time in Section D.
- 944.2.4 The Minimum Time for Section E is three minutes less than the Time Allowed.
- 944.2.5 The Time Limit for Section A is the Time Allowed plus 20%. The Time Limit for Section D and E is twice the Time Allowed.
- 944.2.6 A Competitor who exceeds the Time Limit in any section will be Eliminated.

944.3 Timing

- 944.3.1 Electronic timing equipment should be used for the timing of Competitors in each Section and the Obstacle, whenever possible.
- 944.3.2 Time Keepers at the Start and Finish of each Section must record the start and finishing times for each Competitor on the Section Timer Record and enter the time on the Competitor's Marathon Time Card.

944.4 Start and Finish

- 944.4.1 Competitors should be at the start of Section A at least 10 minutes before their published Start Time.
- 944.4.2 If a Competitor is not ready to start Section A at his scheduled time, the Timekeeper will start him at the earliest available time at his discretion, and record the actual starting time, which must be reported to the Technical Delegate and President of Jury, for onward transmission to the Scorer, at the earliest opportunity. The Competitor will be penalised 0.2 of a penalty per second of the time elapsed between his scheduled start time and the time he was ready to start. For the avoidance of doubt, Competitors will not be penalised where the start of Section A is delayed for organisational reasons.
- 944.4.3 Competitors must start each Section from the halt, with the leading Horse behind the Start line. The Time Keeper will count down to the Start time. If a Competitor starts before the Time Keeper gives him authorisation, he will be recalled, a new start time will be given and the Marathon Time Card will be amended, he/she will be awarded 10 penalties (Article 949.3.43). If the Competitor fails to stop, when recalled, he may be Eliminated. The President of Jury must be made aware of the circumstances as soon as possible. Penalties as per Article 944.4.2 .

944.5 Time Penalties in the Sections

- 944.5.1 In all Sections, Competitors will be penalised 0.2 of a penalty per second for exceeding the Time Allowed.
- 944.5.2 Competitors completing Sections A or E in less than the Minimum Time will be penalised 0.2 of a penalty point for each second they are early.

Rules for International Combined Driving Events

Article 945 PENALTIES ON THE MARATHON COURSE

945.1 Whips

Whips, if carried, can only be used by the Competitor (Driver). Failure to comply will incur 20 penalties.

945.2 Error of Course

945.2.1 In Section A and D if a Competitor fails to pass through a Compulsory Turning Flag (CTF) in the designated sequence, he may return to the point of error and re-drive the CTF, provided he has not driven the following CTF. A Competitor who fails to pass through a CTF in the published sequence will be eliminated.

945.2.2 In Section E, if a Competitor fails to pass through the Compulsory Turning Flags in the designated sequence and direction he will be Eliminated. However he may return to a point of error provided he has not entered the following Obstacle, and drive the Compulsory Turning Flag and those following in the designated sequence. After driving an Obstacle a Competitor may not return to drive a Compulsory Turning Flag located prior to the Obstacle in the published sequence, and will be Eliminated if he does so. Art 943 2.5

945.3 Deviation from the Course

Competitors must not deviate from the track for the last 500 meters or between the last Obstacle and the Finish of Section E, if it is closer than 500 meters. Competitors who stop, circle, zigzag or leave the track in any other way will incur 10 penalties for each occurrence. Exception: see Article 945.7.3

945.4 Incorrect Pace

Should one or more Horses break into a pace other than that specified for Section D and the last 500m of Section E and is not corrected within five seconds the Competitor will incur 1 penalty for every occurrence. If the break continues, the Competitor will incur 1 penalty for every additional completed period of five seconds.

945.5. Intentional Break of Pace

Intentionally cantering or trotting all the Horses in Section D will be penalised by Elimination.

945.6 Dismounting

945.6.1 In Sections A, D and outside the Obstacles in Section E, Grooms and Competitors are not allowed to dismount unless the Vehicle is stationary. If the Vehicle is not stationary, either or both Groom(s) dismounting will incur 10 penalties, the Competitor dismounting will incur 20 penalties.

945.6.2 The Competitor and all Grooms must be on the Vehicle as it crosses the Start and Finish Line and passes through the Compulsory Turning Flags in each Section. Failure to do so incurs 10 penalty points for grooms and 20 penalty points for Competitor, on each occasion.

945.6.3 If warranted due to the condition of the terrain, the Technical Delegate and the President of the Ground Jury may permit Grooms in Competitions for Ponies to run behind their Vehicle on designated parts of the Course only.

945.7 Stopping

945.7.1 Competitors may stop for repairs to Vehicles or Harness or for any reason beyond the Competitor's control, anywhere on the course other than while negotiating an Obstacle, without incurring penalties, other than loss of time, except as in 945.7.2 & 3 below.

945.7.2 Competitors will incur 1 penalty point for each commenced ten seconds that they remain stopped on the course for any other reason.

945.7.3. A Competitor is allowed to stop to carry out necessary repairs as long as he stops within 30 meters after leaving the last Obstacle to make necessary repairs to the harness or vehicle without penalty. Stopping for any other reason between the last Obstacle or the 500 meter sign, whichever is closer to the Finish Line in Section E will incur 10 penalties for each occurrence.

945.8 Damaged Vehicle/Harness

945.8.1 At the Finish of Section E any missing or disconnected trace or pole strap will incur 10 penalties for each occurrence.

945.8.2 At the Finish of Section E a broken or disconnected pole or shaft will incur Elimination.

Rules for International Combined Driving Events

- 945.8.3 Vehicles must pass the Finish of Section E drawn by the number of Horses required for its class and on the designated number of wheels. Failure to comply will incur Elimination. Broken or missing tires are acceptable.

Article 946 OBSTACLE PENALTIES

946.1 Pace in Obstacles

Competitors may use any pace in the Obstacles.

946.2 Error of Course in an Obstacle:

- 946.2.1 Competitors entering any part of an obstacle without first passing through the Entry Flags or failing to pass through the Exit Flags on leaving an Obstacle without correcting the error will be Eliminated.
- 946.2.2 The Compulsory Gates in an Obstacle are "free" after a Competitor has passed through them in the correct direction and in the correct sequence. Competitors may, therefore, go through them again in any direction at any time (for example; Competitors must go through A in the correct direction before going through B. A is now "free" and they may go through it again in any direction as often as they like, and so on).
- 946.2.3 Competitors, who pass through a Compulsory Gate in the wrong sequence or direction before it becomes "free" and without correcting the error before passing through the Exit Flags, will be eliminated.
- 946.2.4 In order to correct an Error of Course, the Competitor must return to and drive the Compulsory Gate he missed before continuing through the next Compulsory Gate in the correct sequence. (For example; a Competitor drives through Compulsory Gates A and B and then goes through D , missing gate C). In order to correct this Error of Course, the Competitor must go back and drive through gate C before going on to gate D etc; all gates are neutralized until he reaches this gate. Each Error corrected shall incur 20 penalties.
- 946.2.5 Passing through the Exit Gate of an Obstacle and stopping the clock without driving all Compulsory Gates in the correct sequence will entail Elimination.
- 946.2.6 A Competitor is not considered to have passed through a Compulsory Gate in an Obstacle until the complete turnout has passed between the Flags denoting the Compulsory Gate.

946.3 Dismounting (See Art 903.3)

- 946.3.1 Each time either or both Grooms put both feet on the ground in an Obstacle, the Competitor will incur 10 penalties.
- 946.3.2 Once Grooms have dismounted they are not required to get back on the Vehicle and need not follow the Competitor through any of the Compulsory Gates in the rest of the Obstacle.
- 946.3.3 Each time a Competitor Dismounts in an obstacle he will incur 20 penalties. He must be on the vehicle when it leaves the Obstacle.
- 946.3.4 A Competitor or Groom may only put one foot on any part of an Obstacle without incurring penalties, contravention of this Article will entail 10 penalties
- 946.3.5 Competitors and Grooms may not touch a Dislodgeable Element, without incurring penalties. Contravention of this Article will entail 10 penalties
Refer to Article 903.3.1 and 3.2
- 946.3.6 A Groom may assist the Driver by leading a horse through the obstacle by the bridle end of the reins. See Art 926.3.5 The Competitor will incur 20 penalties

946.4 Disconnecting

Deliberately disconnecting one or more Horses and leading them through any part of the Obstacle entails Elimination.

946.5 Overturning

A Vehicle overturning in an Obstacle incurs 60 penalties which includes all other penalties.

946.6 Elimination in an Obstacle

The decision whether a Competitor is Eliminated in an Obstacle rests entirely with the Ground Jury.

946.7 Welfare of the Horse

Rules for International Combined Driving Events

- 946.7.1 It is the responsibility of the Competitor to stop immediately and put a Groom or Grooms down whenever a Horse has its leg over a Pole, Lead Bar, Shaft or when a Horse is down and remains down. Also, he must stop when instructed to make necessary repairs by a Member of the Ground Jury or Obstacle Observer. Failure to stop and put the groom down to correct the situation before leaving the Obstacle will incur Elimination. The time will continue to run.
- 946.7.2 It is the responsibility of the Competitor to stop immediately and put a Groom or Grooms down whenever a Horse has a leg over a Trace. Also, he must stop when instructed to correct the situation by a Member of the Ground Jury or Obstacle Observer. Failure to stop and put the groom down to correct the situation before leaving the Obstacle will incur 20 penalties. The time will continue to run.

946.8 Timing

- 946.8.1 The Competitor will be timed from when the nose of the leading horse passes between the entry flags until the nose of the leading horse passes between the exit flags. Other obstacle penalties will continue to apply until the whole turnout has passed the exit flags.
- 946.8.2 Electronic timing equipment should be used to time Competitors through the Obstacles if at all possible. At Championships and CAIO's it is compulsory.
- 946.8.3 The Time Limit for Competitors in Obstacles is five minutes. If Competitors fail to complete the whole Obstacle and pass the Exit flags within the Time Limit, the Obstacle Observer is to blow two blasts on a whistle indicating to the Competitor that the Time Limit has been reached. The Competitor must then vacate the Obstacle as quickly as possible, (with assistance if necessary) and may not continue in the Competition.
- 946.8.4 The time taken for a Competitor to complete an Obstacle shall be recorded to one hundredth of a second, either manually or electronically.
- 946.8.5 There is no rounding of time or conversion to penalty points for individual Obstacles.

946.9 Hold Ups

- 946.9.1 If a Competitor arrives at an Obstacle while the previous Competitor is still negotiating the Obstacle, or if the Obstacle is not ready to be driven, he is to be held at a point on the Course approximately 50m from the Entry Flags.
- 946.9.2 One of the Assistant Obstacle Observers is to stop the Competitor at that point and start his stopwatch. As soon as the previous Competitor is clear of the Obstacle and the Obstacle Observer approves a re-start, the Assistant Obstacle Observer will re-start the Competitor and inform him of the time he has been held. This should be recorded in whole or half minutes.

Article 947 JUDGES

947.1 Positions

- 947.1.1 One Member of the Ground Jury must be at the Compulsory Rest after Section D. The Judge should act on the advice of the Veterinary Delegate to decide whether the Horses are in a fit condition to continue the Competition. The Judge must also supervise the measuring of the vehicles. See Art 918.
- 947.1.2 One Member of the Ground Jury must be at the end of Section E to supervise the inspection of Vehicles ,Harness and marathon time cards and when applicable to supervise the weighing of the Vehicles. A Competitor whose Vehicle is below the minimum allowed weight will be Eliminated.
- 947.1.3 The rest of the Jury will be positioned by the President of the Ground Jury.

Article 948 OFFICIALS

948.1 Ground Observers

- 948.1.1 Ground Observers should be allocated positions around the Course by the Technical Delegate from which they can observe the most critical Compulsory Turning Flags and as much as possible of Section D.
- 948.1.2 Ground Observers must be given the starting order of Competitors, together with copies of Instructions and the Ground Observers Report and a Control sheet.
- 948.1.3 Ground Observers must be given a stopwatch and instructed in its use by the Technical Delegate or his representative so that they are able to time breaks of pace.

Rules for International Combined Driving Events

- 948.1.4 Ground Observers must report all incidents, for which a Competitor may be penalised, and any other information, to the Ground Jury periodically and at the end of their period of duty.
- 948.1.5 Ground Observers cannot Eliminate or otherwise penalise Competitors. It is the responsibility of the Ground Jury to impose appropriate penalties.
- 948.1.6 After the Competition, Ground Observers must remain in the vicinity of the Secretary's Office until dismissed by the President of the Ground Jury.

948.2 Time Keepers

- 948.2.1 Each Time Keeper will be provided with a Chronometer with a "time of day" display and instructed in its use by the Technical Delegate or the Chief Time Keeper. The Technical Delegate or his Assistant is responsible for the synchronisation of the "time of day" on all Chronometers issued to Officials.
- 948.2.2 The Time Keeper at the start of Section A, must be issued with the starting time schedule and must ensure that Competitors have been given a 'Marathon Time Card' (Green Card).
- 948.2.3 All other Time Keepers at the Start and Finish of each Section must be provided with the complete list of Competitors and a running order.
- 948.2.4 Time Keepers are required to record the Start and Finish times for their respective Section and to enter them on the Competitor's 'Marathon Time Card' and the 'Section Timer Record'.
- 948.2.5 Horses must start from the halt with the nose of the leading Horse behind the Start Line.
- 948.2.6 The finishing time will be taken as the nose of the leading Horse crosses the Finish Line.
- 948.2.7 After the Competition, Time Keepers must remain in the vicinity of the Secretary's Office until dismissed by the President of the Ground Jury.

948.3 Obstacle Observers

- 948.3.1 There must be one Obstacle Observer at each Obstacle. Each Obstacle Observer must have at least two assistants. The Obstacle Observer must be given a whistle and two stopwatches and instructed in their use by the Technical Delegate or his Assistant. They must record, the exact time to 1/ 100th second taken by each Competitor through the Obstacle.
- 948.3.2 Obstacle Observers must be given a Starting Order listing all Competitors together with sufficient copies of Obstacle Reports and diagrams to record each Competitor's time and route through the Obstacle.
- 948.3.3 Obstacle Observers must record and report all incidents, which might entail a Competitor being awarded penalties to the Ground Jury, as soon as possible after the incident occurred.
- 948.3.4 After the Competition, Obstacle Observers must remain in the vicinity of the Secretary's Office until dismissed by the President of the Ground Jury.

Article 949 CLASSIFICATION

949.1 Conversion of Time to Penalties

- 949.1.1 The total time taken by the Competitor in the Obstacles will be recorded to 1/100 second, and penalties will be calculated to 2 decimal places. Any time over the Time Allowed in each of the Sections, will be added together and multiplied by 0.2. Any time under the Minimum Time in Sections A and E will be added together and multiplied by 0.2. There shall be no rounding of times. The penalties for under Minimum Time; plus penalties for over Time Allowed and the total Obstacle times shall be added to any other driving penalties received to determine the final score for each Competitor in Competition B.
- 949.1.2 For Competitors who are Eliminated or Retire. See Article 902.5 & 902.6.
- 949.1.3 The Competitor with the lowest number of penalties will be the winner of the Competition.
- 949.1.4 In the event of an equality of penalties, the Competitor with the lowest number of penalties in Section E will be placed first. If there is still equality, the Competitor with the lowest number of penalties in Section D will be placed first.

949.2. COMPETITION B SUMMARY

Rules for International Combined Driving Events

	Division class	Min. Weight	Max. Distance	Max. km/h 3 section	Min. Track width (cm)
Horse	Four-In-Hand	600 kg	18 km	15/7/14	125 cm
	Pair	350 kg			
	Tandem	150 kg			
	Single	150 kg			
Pony	Four-In-Hand	300 kg	18 km	14/6/13	125 cm
	Pair	225 kg			
	Tandem	90 kg			
	Single	90 kg			

5 section marathon see Annex 6

949.3 Summary of Penalties in Competition B

949.3.1	Art. 917.2.5	Person tied to the vehicle	Elimination
949.3.2	Art. 902.5.1	Contravening the Rules	Elimination
949.3.3	Art. 918.1.2.	Vehicles below weight at End of E or below width at Start of E.	Elimination
949.3.4	Art. 945.2, 945.6	Required persons not on Vehicle passing through a Compulsory Turning Flag, or the Start and Finish of each Section, each occasion.	10 penalties
949.3.5	Art.902.8.2 / 924.3	Horses unfit to continue at End of Section D.	Elimination
949.3.6	Art. 942.5.3	Dislodging a Dislodgeable Element.	2 penalties
949.3.7	Art. 942.5.5	Preventing a Dislodgeable Element from being dislodged.	10 penalties
949.3.8	Art. 943.3.5	Motorised vehicles or bicycles in Obstacles. First Incident Second Incident	Warning Yellow card
949.3.9	Art. 944.2.6	Exceeding the Time Limit in any Section.	Elimination
949.3.10	Art. 945.8.1	Finishing Section E with missing or disconnected Pole strap or Trace for each occurrence.	10 penalties
949.3.11	Art. 944.5.1	Total time over Time Allowed in all Sections.	0.2 penalties/sec.
949.3.12	Art. 944.5.2	Total time under Minimum Time in A and E.	0.2 penalties/sec.
949.3.13	Art. 949.1.1	Total time in Obstacles.	0.2 penalties/sec.
949.3.14	Art. 945.2.2	Failing to pass through Compulsory Turning Flags and Obstacles in correct sequence.	Elimination
949.3.15	Art. 945.3	Each deviation from Course after last Obstacle.	10 penalties
949.3.16	Art. 941.5 / 945.4	Incorrect pace.	1 penalty for every 5 sec.
949.3.17	Art. 944.4.2	Not ready to Start A.	0.2 penalties/sec.
949.3.18	Art. 945.5	Intentional break of pace in Section D.	Elimination
949.3.19	Art. 945.6.1	Dismounting while moving.	10 penalties

Rules for International Combined Driving Events

949.3.20	Art. 946.7	Failing to stop for leg over Pole, Lead Bar or Shaft. Failing to stop for leg over Trace.	Elimination 20 penalties
949.3.21	Art. 917.2.4	Groom handling Reins when Vehicle not stationery.	20 penalties
949.3.22	Art. 945.8.3	Finishing Section E with less horses than required.	Elimination
949.3.23	Art. 945.8.3	Finishing Section E with missing wheel.	Elimination
949.3.24	Art. 945.8.2	Finishing Section E with broken or disconnected pole or shaft	Elimination
949.3.25	Art. 946.2.1	Failing to pass through entry Flags of an Obstacle.	Elimination
949.3.26	Art. 946.8.3	Failing to pass through Exit Flags of an Obstacle within 5 minutes.	Elimination
949.3.27	Art. 946.2.3	Passing a gate in wrong sequence or direction.	Elimination
949.3.28	Art. 946.2.4	For correcting each Error of Course in an Obstacle.	20 penalties
949.3.29	Art. 946.2.5	Passing between Exit Flags before completing an Obstacle.	Elimination
949.3.30	Art. 946.3.1	Groom(s) dismounting in an obstacle, each occasion.	10 penalties
949.3.31	Art. 946.3.3	Competitor dismounting in an Obstacle.	20 penalties
949.3.32	Art. 946.5	A vehicle turning over in an Obstacle.	60 penalties
949.3.33	Art. 946.4	Disconnecting and leading through an Obstacle.	Elimination
949.3.34	Art. 946.8.3	Exceeding Time Limit in an Obstacle (5 min.)	Elimination
949.3.35	Art. 926	Outside Assistance.	Elimination
949.3.36	Art. 918.1.3	No Breeching with a vehicle with no brakes.	10 penalties
949.3.37	Art. 926.3.5	Groom leading a horse through an obstacle.	20 penalties
949.3.38	Art. 917.2	Substitution of a Groom.	Elimination
949.3.39	Art. 917.6	Driver or Groom wearing shorts.	10 penalties
949.3.40	Art. 917.6.2	No hard hat and/or back protector on Section E.	Elimination
949.3.41	Art. 946.3.4	Two feet on an Element of Obstacle.	10 penalties
949.3.42	Art. 913.3	Contravening the rules on advertising.	20 penalties
949.3.43	Art. 945.1	Contravening the rule on the use of the whip	20 penalties
949.3.44	Art. 944.4.3	Starting before the signal and returning when recalled	10 penalties
949.3.45	Art. 944.4.4	Competitor fails to stop when recalled	Elimination

Rules for International Combined Driving Events

Chapter IV COMPETITION C: OBSTACLE-CONE DRIVING

Article 950 GENERAL

The object of Competition C – Obstacle- Cone Driving – is to test the fitness, obedience and suppleness of the Horses after the Competition B, and the skill and competence of the Competitors.

950.1 Competitions

- 950.1.1 The Fault Competition (Article 954) or Competition in Two Sections (Article 960) shall be used in Combined Driving Events.
- 950.1.2 The Fault Competition (Article 954) is conducted on the basis of penalties for Obstacles knocked down and for exceeding the Time Allowed. The score from this round will always be used solely to decide the Final Classification in all Events.
- 950.1.3 Championship and CAIO events may have a Drive- off (Article 958) between all Competitors with zero penalties, or equality of penalties, to determine the winner of Competition C.
- 950.1.4 Competitions in two rounds and a Drive Off. 25% of Competitors may return for the second round to determine the winner of Competition C, in any case all those with zero penalties. In case of equality of penalties for first place there will be a drive- off.
- 950.1.5 The Time Competition (Article 959) is conducted on the basis of the time in seconds taken by Competitors to complete the Course, with any penalties for faults converted to penalty seconds (refer to Article 959). Time Competitions are only to be used to determine the placings in Competition C.
- 950.1.6 The Competition with a Winning Round. A Competition run over one round according to penalties and time which will count for the final classification in the Combined Driving Event, and a Winning Round to determine the placings in Competition C.
 - 950.1.6.1 The initial round is run according to Penalties and Time. 25% of the Competitors from the first round return for the Winning Round, in any case, all those with zero penalties in the initial round.
 - 950.1.6.2 Competitors may or may not, (depending on the requirements laid down in the schedule) carry their penalties from the initial round forward to the Winning Round.
 - 950.1.6.3 The Winning Round is run against the clock.
 - 950.1.6.4 The starting order in the Winning Round is according to the reverse order of penalties and time in the initial round.
 - 950.1.6.5 Competitors are placed according to their penalties and time in the Winning Round, or according to their aggregate penalties in the first and Winning Rounds, to determine the placings in Competition C.
 - 950.1.6.6 In case of a tie on penalties for any place, Competitors are placed according to their time in the Winning Round and if necessary their time in the initial round.

Article 951 THE COURSE

951.1 Building and Measuring the Course

- 951.1.1 The Course Designer is responsible, under the supervision of the Technical Delegate, for laying out, marking and measuring the Course, building the Obstacles.
- 951.1.2 The Arena should be not less than 70m x 120m or an equivalent area. Should this not be possible the number of Obstacles must be reduced accordingly, unless an exception is granted by the Technical Delegate.
- 951.1.3 The Starting and Finishing lines may not be more than 40m nor less than 20m from the first and last Obstacles respectively.
- 951.1.4 The number of Obstacles may not exceed 20. Exceptions see Art 960.3 The length of the Course must be between 500m and 800m.
- 951.1.5 Courses must be laid out so that Competitors have a chance to maintain a reasonably fast pace throughout the major part of the Course. Certain Obstacles, and combinations of Obstacles, will inevitably slow down the pace, but such a layout should be limited to a small proportion of the whole Course (refer to Annex 7 for the dimensions of Multiple Obstacles).

Rules for International Combined Driving Events

Article 952 OBSTACLES

952.1 Cones

- 952.1.1 The Cones forming an Obstacle must be at least 30 cm high and made of indestructible plastic material. A weighted ball must be placed in the hollow on top of the Cone, so that it falls down only if the Cone is touched.
- 952.1.2 All Obstacles consisting of a single pair of Cones will constitute a Single Obstacle.
- 952.1.3 The Obstacle includes: Cones, red and white markers, numbers and letters.
- 952.1.4 The position of one of the pair of Cones must be marked on the ground so that a constant position of the Obstacle is maintained throughout the Competition. Where practicable a line will also be drawn to ensure that the other Cone is maintained at the correct angle.
- 952.1.5 Obstacles that entail reining back are not permitted.

952.2 Multiple Obstacles

- 952.2.1 Multiple Obstacles must conform to the design principles illustrated in Annex 7 – Closed Multiples or Annex 8 - Open Multiples. Variations or new designs must be pre-approved by the FEI Driving Committee and included in the Event Schedule.
- 952.2.2 A Multiple Obstacle may be constructed of markers or horizontal rails, elevated to a minimum of 40 cm and maximum of 60 cm in height.
- 952.2.3 Each group of Cones or Elements must be clearly separated and associated with one of the sections of the Multiple.
- 952.2.4 A Multiple Obstacle, other than a "Serpentine", "Zig- Zag", a "Double Box" or a "Double U" must not consist of more than three pairs of Cones or Dislodgeable Elements.
- 952.2.5 Other than Serpentine, Zig-Zags, Double Boxes and Double Us, a Multiple Obstacle may not be longer than 30m measured along the centre line through the Obstacle.
- 952.2.6 There may not be more than 3 of the following Multiple Obstacles in any course. Serpentine, Zig-Zag, Double Box, Double U and Double L.
- 952.2.7 In Multiple Obstacles Competitors can only incur a maximum of 6 penalties in a Double (A & B), 9 penalties in a Triple (A, B & C) and 12 penalties in a Serpentine, Zig-zag, Double Box, or Double U (A, B, C & D), per attempt plus any penalties for a rebuild as well as penalties for Disobedience.
- 952.2.8 Multiple Obstacles may not be used in a Drive- Off. (Refer to Article 958 – Drive-off and Article 953 – Technical Summary).

952.3 Serpentine, Zig-Zags, Double Boxes and Double U

- 952.3.1 A Serpentine consists of 4 cones in a straight line facing in alternate directions lettered A, B, C, D (refer to Annex 8.1).
- 952.3.2 A Zig-zag consists of not more than 4 pairs of Cones, with alternate left and right Cones in a straight line (refer to the Annex 8.2). All centre line Cones must be placed in a straight line, either at the front, middle or rear of the Cone.
- 952.3.3 A Double Box and a Double U are illustrated in Annex 8.

952.4 Water and Bridges

- 952.4.1 Water Obstacles and Bridge Obstacles; Prior notification must be given in the Schedule for the Event.
- 952.4.2 Water Obstacles must be at least 3m wide, with a depth between 20 and 40 cm and sloping sides. There must be a pair of Cones at the Entrance (flag lettered A) and Exit (flag lettered B) with the Cones at least 2.5m apart. Knocking down a ball or balls on either A or B will be penalised as 3 penalties for each pair of cones.
- 952.4.3 Wooden Bridges, or Bridges of similar suitable construction approved by the Technical Delegate, with fan shaped wings at the entrance, with the bridge surface not more than 20 cm above the ground, with a usable width of three meters, and a maximum length of ten meters are permitted, boarded or rail sides are essential. The Technical Delegate may grant exceptions if the Bridge is of a permanent solid construction with strong side rails. There must be a pair of Cones at the Entrance (flag lettered A) and Exit (flag lettered B) with the Cones at least 2.5m apart. See Annex 9.
- Knocking down a ball or balls on either A or B will be penalised as 3 penalties for each pair of cones.

Rules for International Combined Driving Events

952.5 Markers

- 952.5.1 Each Obstacle is defined by a Pair of Markers; a Red Marker on the right hand side and a White Marker on the left hand side as Competitors approach the Obstacle. They are placed not more than 15 cm outside the elements, which form the Single and Multiple Obstacles.
- 952.5.2 Turning posts, decorations, and obstructions may be placed on the Course before the official course walk. No penalty is incurred if they are touched, displaced or knocked over.
- 952.5.3 All Obstacles on the Course must be numbered in the sequence in which they are to be driven. The number of each Obstacle must be indicated on a board placed at the Entrance to each Single and Multiple Obstacle.
- 952.5.4 Each distinct section of a Closed Multiple Obstacle (Ls, Us and Boxes) must be clearly marked, in different colours as indicated in Annex 7 Multiple Obstacles. The entire turnout must pass between these markers in the correct alphabetical order.
- 952.5.5 The Red and White Markers and the numbered and lettered boards may be combined, so that the numbers and letters appear on the same posts as the Red and White Markers, or they may be on separate boards or discs. If possible the numbers of the Obstacles should be placed so that Competitors can see them as they leave the previous Obstacle.

952.6 Plan of the Course

At least 2 hours before the start of Competition C, a plan of the Course must be given to the Competitors. At least one hour before the start of the Competition for each class in the Event, a plan must be posted in the Collecting Ring showing the length, speed in meters per minute and the Time Allowed for that Class.

952.7 Inspection of the Course

- 952.7.1 The Course must be open for inspection at least one hour before the start of the Competition. Only Competitors, Chefs d'Equipe and Trainers are allowed to inspect the Course on foot and they must be smartly dressed. Competitors, Chef d'Equipes and Trainers are not permitted to use measuring wheels when inspecting the Course. At an Event, a warning will be issued for the first offence and a Yellow Warning Card from the President of Jury for subsequent offences.
- 952.7.2 Only the Course Designer and his staff may alter or work on any part of the Course .If any Competitor, or any person associated with him, alters the Course in any way, the Competitor will be eliminated.

Article 953 COMPETITION C SUMMARY

	Division class	Speed M/mi n	Cones Width (cm)	Serpen- tine	Zig- zag	L	U	Single	Min. Track (cm)
Horse	Four-In-Hand	230	190	12	12	4/4	4/5/5	15	158
	Tandem		170						138
	Pair	250		8	11	3/3	3/4/4	12	148
	Single	250	160						138
Pony	Four-In-Hand	230	170	10	10	3/3	3/4/4	12	138
	Tandem	240							138
	Pair	250	160	8					138
	Single								

Drive-offs and Winning-Round:

Speed – may be increased by a maximum of 10 m/minute

Cones width – may be increased by 10cm at the discretion of the Ground Jury and Organising Committee

Rules for International Combined Driving Events

Article 954 THE FAULT COMPETITION

954.1 Starting the Competition

- 954.1.1 When the Technical Delegate is satisfied that the Course is fully prepared he is to report this to the President of the Ground Jury, who will then authorise the start of the Competition.
- 954.1.2. Once the Competition has started, the Ground Jury may increase the time allowed after the third completed round. If the time allowed is increased, any time penalties of the Competitors who have completed the Course before the revised time is announced shall be adjusted accordingly. Time Allowed may not be reduced.

Article 955 STARTING ORDER

Retired Competitors will start first in numerical order, followed by Eliminated Competitors in numerical order. They will be followed by the Competitor with the highest total number of penalties in Competitions A and B. The Competitor with the lowest total number of Penalties will start last.

Article 956 PENALTIES

956.1 Competitors

- 956.1.1 Competitors who have entered the Arena but fail to Start by passing through the Start Line within 60 seconds of the starting signal will be penalised 5 penalty points.
- 956.1.2 If a Competitor fails to enter the Arena when the Course is ready, the President of Jury will ring the bell to signify the Start for that Competitor. If the Competitor has not entered the arena within 60 seconds of the first bell, the bell will be rung again and that Competitor is then Eliminated.
- 956.1.3 Competitors starting and passing through an Obstacle before the starting signal will be penalised 10 penalty points and must restart.
- 956.1.4 Competitors, who present an Obstacle to their Horse or drive through any gate of an obstacle before starting the Course , will be penalised 10 penalties.
- 956.1.5 The Start and Finish lines are neutralised for passing through, from the moment the Competitor has passed through the Start line until the Competitor has passed through the last Obstacle.
- 956.1.6 Knocking down one or both balls of a Single Obstacle and knocking down a ball or an element of a Multiple Obstacle incurs 3 penalties in each case.
- 956.1.7 Knocking down a ball or balls on either A or B on a Water or Bridge Obstacle will incur 3 penalties for each pair of cones
- 956.1.8 Grooms must remain seated in their proper places, between the Start and Finish Lines. They are not allowed to stand behind the Competitors or indicate the Course or to speak unless they are dismounted. Competitors, whose Grooms fail to comply will be Eliminated.
- 956.1.9 After the last Obstacle the Competitor must pass through the Finish line with the Red Flag on the right and the White flag on the Left.
- 956.1.10 Competitors may be fined up to CHF 500 by the Appeal Committee if they pass through a numbered Obstacle after crossing the Finish Line.
- 956.1.11 A Competitor may pass between the elements of an Open Multiple Obstacle whilst driving between Obstacles, without incurring a penalty.

956.2 Error of Course

- 956.2.1 A Competitor is considered to have passed through a gate in an Obstacle when the whole turnout has passed between the Markers.
- 956.2.2 If a competitor attempts to pass through or intentionally drives over any part of an obstacle in the wrong sequence or direction then the President of Jury must wait until the whole turnout has passed through the obstacle before ringing the bell. In both cases the penalty is Elimination.
- 956.2.3 If a Competitor knocks down or dislodges any part of an Obstacle, which has already been driven, he will incur 3 penalties.
- 956.2.4 If any part of an Obstacle in advance of the one being driven is dislodged or knocked down, the President of the Ground Jury will ring the bell and stop the clock for the Obstacle to be re-built. The Competitor will incur 3 penalties and 10 seconds will be

Rules for International Combined Driving Events

added to their time. The clock will re-start when the Competitor is approximately 10 meters from the re-built Obstacle.

956.2.5 If the Jury sounds the whistle/bell while the Competitor is on the Course, the Competitor must halt immediately. If the Competitor does not halt, the President of Jury will blow the whistle/ bell a second time. If the Competitor continues without stopping, he is Eliminated. The Groom may advise the Competitor that the whistle/ bell has sounded.

956.2.6 If the Jury is in doubt whether an Obstacle has been properly driven, the Competitor must be allowed to finish the Course. The Jury can then reach a decision.

956.3 Obstacle Rebuild

956.3.1 If the Competitor knocks down any part of an Obstacle in the process of a disobedience or refusal, the bell will be rung and clock stopped for the Obstacle to be rebuilt and ten seconds will be added to the Competitor's time along with any penalties for Disobedience.

956.3.2 When the Obstacle has been rebuilt the bell will be rung again and the Competitor must then retake the complete Obstacle and continue his round. The clock will re-start when the Competitor is approximately 10 m from the re- built Obstacle.

956.3.3. If a Competitor knocks down any part of a Multiple Obstacle in advance of the element he is driving, or if he breaks out of the Multiple Obstacle, then the bell will be rung, the clock stopped while the obstacle is rebuilt and 10 seconds added to the total time taken. He will be penalised for Disobedience but not for the elements he knocked down while having the Disobedience.

956.4 Broken Harness

If, at any time, after he has started, a Competitor has a disconnected pole, shaft, rein, trace, pole strap or chains, or should a Horse have a leg over the pole, trace, shaft, or leader bars the President of the Jury must ring the bell and stop the clock. The Competitor must put a Groom(s) down to correct the problem and will be penalised for a Groom dismounting. After the situation has been corrected and the Groom has remounted the President of the Jury will ring the bell and restart the clock.

956.5 Competitors and Grooms Dismounting.

956.5.1 Each time a Competitor dismounts he will incur 20 penalties.

956.5.2 Competitors will incur penalties each time one or both Grooms dismount. 5 penalties on the first occasion, 10 penalties on the second occasion. On the third occasion the Competitor is Eliminated.

956.5.3 The Grooms must be on the Vehicle when going through each Obstacle. However a Groom(s) may dismount to assist through an Obstacle by leading the horse by the bridle ends of the reins while the horse is still attached to the vehicle. See Article 926.3.5 Also any other penalty incurred under Article 926.2.1. The Groom(s) must remount before the next Obstacle.

956.6 Whips see Art 917.3

956.7. Disobedience and Resistance

956.7.1 When the Competitor attempts to pass through an Obstacle and his Horse shies away from the Obstacle at the last moment without hitting any part of the Obstacle.

956.7.2. When the Horses run away, or, in the opinion of the President of the Jury, the Competitor has lost effective control.

956.7.3 A Disobedience will incur 5 penalties for the first, 10 penalties for the second and Elimination for the third instance. Penalties for Disobedience are cumulative wherever they may occur on the Course.

956.7.4 Competitors do not incur any penalties if they stop in front of an Obstacle, or in a Multiple Obstacle, without knocking down any element and then immediately drive cleanly through the Obstacle.

956.7.5 If Horses and Vehicle come to a complete halt and if any horse steps back, it is penalised for a Disobedience.

956.7.6 In an Open Multiple Obstacle (serpentine, zig- zag) if there is Disobedience, the combination must be retaken from the beginning.

956.7.7 It is not a Disobedience to circle, pass the extended line or cross own line, except in an Open Multiple Obstacle.

Rules for International Combined Driving Events

956.7.8 If a Competitor has a Disobedience at any Obstacle and knocks down any part of that obstacle he will only incur penalties for the Disobedience and 10 seconds will be added for the rebuild.

956.7.9. A Horse is considered to offer resistance if, at any time and for whatever reason it refuses to go forward (with or without moving back), turns around, rears. This will be penalised as Disobedience.

956.8 Timing

956.8.1 Each Competitor will be timed by stopwatch or by an electronic timing device, from the moment the nose of the leading Horse crosses the Start Line until the nose of the leading Horse crosses the Finish Line.

956.8.2 Electronic timing must be used at Championships and CAIO's.

956.8.3 Times must be recorded to one hundredth of a second.

956.8.4 The Time Limit is twice the Time Allowed. Exceeding the Time Limit will incur Elimination.

956.8.5 The Time Allowed is calculated using the following speeds in meters per minute:

Class (Horses)	First Course	Class (Ponies)	First Course
Four-in-hand	230	Four-in-hand	230
Pair	250	Pair	250
Tandem	230	Tandem	240
Single	250	Single	250

956.8.6 For a drive-off, the speed may be increased by a maximum of ten meters per minute.

956.8.7 Penalty for exceeding the time allowed, total time taken by the Competitor to 1/100 second, and any time over the time allowed, multiplied by 0.5. Penalties will be calculated to two decimal places.

Article 957 SUMMARY OF PENALTIES IN COMPETITION C

Penalties		Fault Competition	Timed Competition
1	Starting:		
1.1	Starting and passing through an Obstacle before the bell is rung. Art. 956.1.3	10 penalties and restart.	10 seconds and restart
1.2	Failing to Start within 60 seconds of bell ring. Art. 956.1	5 penalties	5 seconds
2	Failing to pass through Start or Finish Lines. Art. 656.1.1,956.1.9	Elimination	Elimination
3	Incomplete Presentation:		
3.1	No reflectors or rear/forward facing lamp. Art. 918.2	Maximum 5 penalties	Maximum 5 seconds
3.2	No breeching with a vehicle with no brakes. Art. 918.1.3	10 penalties	10 seconds
3.3	Competitor entering arena without hat, jacket, gloves or apron. Art. 917.5	5 penalties	5 seconds
3.4	Groom entering arena without jacket, hat or gloves. Art. 917.5	5 penalties	5 seconds
4	Driving without a Whip in the Arena 917.3	10 penalties	10 seconds

Rules for International Combined Driving Events

4.1	Dropping or putting down the whip. Art. 917.3	10 penalties	10 seconds
5	For knocking down one or two balls in the same single Obstacle. Art. 956.1.6	3 penalties	3 seconds
6	For knocking down an element of a Multiple Obstacle. Art. 956.1.6	3 penalties	3 seconds
7	For knocking down any part of an Obstacle after it has already been driven. Art 956.2.3	3 penalties	3 seconds
8	If any part of an Obstacle in advance of the one being driven is knocked down, the bell will be rung for the Obstacle to be rebuilt. Art. 956.2.4	3 penalties and add 10 seconds	3 seconds and add 10 seconds
9	Taking an Obstacle out of sequence. Art. 956.2.2	Elimination	Elimination
10	For causing an Obstacle, or part of a multiple to be rebuilt. Art. 956.3.3	3 penalties and add 10 seconds	3 seconds and add 10 seconds
11	Disobedience: Art. 956.7.3		
11.1	First incident	5 penalties	5 seconds
11.2	Second incident	10 penalties	10 seconds
11.3	Third incident	Elimination	Elimination
12	Competitor dismounting Art. 956.5.1	20 penalties	20 seconds
13	Groom(s) dismounting. Art 956.5.2		
13.1	First incident	5 penalties	5 seconds
13.2	Second incident	10 penalties	10 seconds
13.3	Third incident	Elimination	Elimination
14	Groom Interference		
14.1	If a Groom handles the Reins, Brake or uses the Whip before the Competitor has crossed the Finish Line. Art. 926.2.1	20 penalties	20 seconds
14.2	If a Groom does not remain seated in his proper place (except to dismount) Art. 926.2.1	Elimination	Elimination
14.3	If a Groom talks to the competitor while on the Vehicle. Art. 926.2.1 Exception Art. 926.2.1	Elimination	Elimination
14.4	If a Groom indicates the course to the Competitor in any way. Art. 926.1 and 956.1.8	Elimination	Elimination
15	Illegal Outside Assistance. Art. 926	Elimination	Elimination
16	Vehicle overturning. Art. 918.1.11	Elimination	Elimination

Rules for International Combined Driving Events

17	For Exceeding the Time Allowed. Art. 956.8.7	0.5 penalties per second	0.5 time penalties per second
18	Exceeding the Time Limit. Art. 956.8.4	Elimination	Elimination
19	Failure to halt after the bell is rung a second time. Art. 956.2.5	Elimination	Elimination
20	Groom leading a horse through an Obstacle. Art. 926.3.5	20 penalties	20 seconds
21	Contravening Rules on Advertising Art. 913.2	20 penalties	20 seconds
22	For intentionally driving over any part of an obstacle Art. 956.2.2	Elimination	Elimination

Article 958 DRIVE- OFF

958.1 Classification

- 958.1.1 In the event of equality of penalties for first place, a drive-off against the clock may take place according to the provisions of the schedule, either over the same course or over a shortened course.
- 958.1.2 The width between the cones may be increased by 10 cm. at the discretion of the Ground Jury and the Organising Committee.
- 958.1.3 If no provision is made for a Drive-Off in the Schedule, the Competitors with equality of penalties for any place are placed in accordance with the time taken to complete the first round. In case of equality of penalties and time, the Competitors concerned will be given equal placing.
- 958.1.4 If the schedule of a Combined Driving Event includes special prizes for Competition C but does not provide for a drive-off, the classification may be decided by time in the first round.

958.2 Multiple Obstacles

Multiple Obstacles are not permitted in a Drive- Off.

958.3 Starting Order

The Starting Order for a Drive- Off will be determined by a draw.

Article 959 TIME COMPETITION

959.1 Obstacles

The Rules concerning the number, type and dimensions of obstacles and the length of the Course must be the same as for a Fault Competition.

959.2 Pace:

Horses		Ponies	
Class	1 st Course	Class	1 st Course
Four-in-hand	230 m/min	Four-in-hand	230 m/min
Pair	250 m/min	Pair	250 m/min
Tandem	230 m/min	Tandem	240 m/min
Single	250 m/min	Single	250 m/min

959.3 Classification

- 959.3.1 Classification will be decided by adding any penalty seconds to the time taken by the Competitors to complete the Course.
- 959.3.2 In the case of equality for first place, the result may be decided either by the lowest number of penalty seconds incurred, or by a Drive-Off, according to the provisions of the Schedule, either over the same course or over a shortened Course. The width between cones may be increased by 10 cm at the discretion of the Ground Jury.

Rules for International Combined Driving Events

Article 960 COMPETITION IN TWO SECTIONS

960.1 Description

- 960.1.1 This Competition comprises two Sections run without interruption, each at an identical or different speed, the Finishing Line for the First Section being the Start Line for the Second Section.
- 960.1.2 A Competition in Two Sections, run under the following Rules, may be used in all Competition C Events.

960.2 Competition Conditions

- 960.2.1 The First Section is run according to the Rules for a Fault Competition with a Time Allowed and the Second Section is run according to the Rules for a Time Competition.
- 960.2.2 The First Section of this Competition will be conducted using the Rules for the Fault Competition Art 952, 953, 954, 955, 956, 957, and the Second Section will be conducted using the Rules for the Time Competition. Penalties for both Sections are listed under Art 957

960.3 Obstacles

- 960.3.1 The First Section is a Course of 14 to 16 Obstacles. The Second Section takes place over 7 to 9 Obstacles (not to exceed 23 Obstacles in total).
- 960.3.2 Multiple Obstacles may not be used in the Second Section.
- 960.3.3 The width between cones may be increased by 10 cm in the Second Section at the discretion of the Ground Jury.

960.4 Penalties

- 960.4.1 Competitors incurring penalties in the first section are halted by ringing the bell after they have passed the last Obstacle or when the Time Allowed for the First Section has been exceeded after crossing the Finishing Line of the First Section. They must stop after crossing the first Finishing Line once the bell is rung.
- 960.4.2 Competitors not penalised in the first Section and not over the time allowed, continue the Course which finishes after crossing the second Finishing Line.
- 960.4.3 The Second Section is run with time driving penalties calculated at one penalty per commenced second. 3 seconds will be added to the time taken for each Obstacle dislodged or ball down. Penalties on the Second Section are calculated as 3 time penalties for every obstacle or ball dislodged added to 0.5 penalties per second for exceeding the time allowed.

960.5 Classification

- 960.5.1 Competitors are placed as follows:
 - 960.5.1.1 According to time and added penalties converted into time in the Second Section; all others according to penalties in the First Section.
 - 960.5.1.2 In the event of equality for first place, a drive-off against the clock with six Obstacles of the first and/or of the second Section may be held according to the conditions of the Schedule.
 - 960.5.1.3 Competitors stopped after the first Section may only be placed after Competitors who have taken part in both Sections.

Rules for International Combined Driving Events

ANNEX 1: CLASSIFICATION OF INTERNATIONAL JUDGES

1. Categories of Judges

Judges are divided in three categories:

- 1.1 International Candidate Judge.
- 1.2 International Judge.
- 1.3 Official International Judge.

2. Qualification Requirements for Judges

- 2.1 International Candidate Judge.

The qualification requirements to become an International Candidate Judge are as follows:

- 2.1.1 To have shown experience as a National Judge of highest national qualification by judging regularly over a period of at least five years, including acting during the current or preceding two years as President or Member of the Ground Jury at three CANs under FEI Rules or as a member of the Ground Jury at two CAI Bs.
- 2.1.2 To have attended and passed at least one FEI course for International Candidate Judges.
- 2.1.3 To understand and speak one of the Official two languages.

- 2.2 International Judge.

The qualification requirements to become an International Judge are as follows:

- 2.2.1 To have served as an International Candidate Judge for at least two years or two complete seasons.
- 2.2.2 To have acted as member of the Ground Jury at two CAIs during the current or preceding two years.
- 2.2.3 To have qualified at an FEI course for International Judges within the past four years.
- 2.2.4 To understand and speak one of the official two languages.
- 2.2.5 Not more than five years to have elapsed since first appointed as International Candidate Judge.

- 2.3 Official International Judge. The qualification requirements to become an Official International Judge are as follows:

- 2.3.1 To fulfil and continue to fulfil the qualification requirements for International Judges.
- 2.3.2 To have had considerable experience, proven by excellent performance as President of the Ground Jury at major FEI events.

3. Promotion of Judges

- 3.1 International Candidate Judge.

The FEI maintains a list of qualified International Candidate Judges who have been recommended by their NFs, and who have been accepted by the FEI Driving Committee.

- 3.2 International Judge.

The FEI maintains a list of qualified International Judges who have been appointed and recommended by the FEI Driving Committee following receipt of recommendation from the relevant NF.

- 3.3 Official International Judge.

The FEI maintains a list of qualified Official International Judges who have been selected by the Bureau from the list of International Judges after consultation with, and the recommendation of the FEI Driving Committee.

4. Limitations

- 4.1 A Judge must meet the qualifications for an International Judge, and be recommended by the NF, and be appointed by the FEI Driving Committee within five years of becoming an International Candidate Judge. In addition, he must be able to understand English and must be able to speak one of the two FEI official languages. At the end of the five-year period, the International Candidate must be promoted or dropped from the list.
- 4.2 International Judges who are no longer able or willing to act regularly will be removed from the FEI list by the FEI Driving Committee.

Rules for International Combined Driving Events

- 4.3 Judges of all categories must retire at the end of the year in which they reach the age of 70. In very special circumstances and on the recommendation of the FEI Driving Committee the age limit may be extended for a further 4 years.
- 4.4 To retain their status, Judges must attend a clinic or seminar every four years for their respective category. Otherwise they may be removed from the list at the discretion of the Driving Committee.
- 4.5 An International Candidate and International Judge must officiate as member of the Ground Jury at an international event at least once every five years or, at the discretion of the Driving Committee, have his/ her name removed from the FEI list of Judges.

Rules for International Combined Driving Events

ANNEX 2 CLASSIFICATION OF COURSE DESIGNERS

1. Categories of International Course Designers

Course Designers are divided into three categories:

- 1.1 International Candidate Course Designer.
- 1.2 International Course Designer.
- 1.3 Official International Course Designer.

2. Qualification Requirements for Course Designers

2.1 International Candidate Course Designer

The qualification requirements to become an International Candidate Course Designer are as follows:

- 2.1.1 To have regular practice as a National Course Designer of the highest national qualification over a period of at least five years. This requirement may be reduced if the candidate has experience as an international competitor.
- 2.1.2 To have assisted as Assistant Course Designer during at least one CAI A and one CAI B and to have received a favourable report from the acting Technical Delegate.
- 2.1.3 To understand and speak one of the official two languages.
- 2.1.4 To have attended and passed at least one FEI Course for International Candidate Course Designers.

2.2 International Course Designer.

The qualification requirements to become an International Designer are as follows:

- 2.2.1 To regularly practice Course Designing and to have designed at least two CAI B's.
- 2.2.2 To have qualified at an FEI course for International Course Designers within the past four years with a recommendation from the Course Director.
- 2.2.3 To understand and speak one of the official two languages.

2.3 Official International Course Designer

The qualification requirements to become an Official International Course Designer are as follows:

- 2.3.1 To fulfil and continue to fulfil the qualification requirements for International Course Designers
- 2.3.2 To have had considerable experience proven by excellent performance as Course Designer at major FEI events.

3. Promotion of Course Designers

3.1 International Candidate Course Designer.

The FEI maintains a list of qualified International Candidate Course Designers who have been recommended by their NF and who have been accepted by the FEI Driving Committee. They must meet the qualifications of an International Candidate Course Designer before they may be recommended by their N F.

3.2 International Course Designer.

The FEI maintains a list of qualified International Course Designers who have been appointed by the FEI Driving Committee following receipt of recommendation from their relevant NF. They must meet the qualifications of an International Course Designer before they may be appointed.

3.3 Official International Course Designer.

The FEI maintains a list of qualified Official International Course Designers who have been selected by the Bureau from the list of International Course Designers after consultation with the Bureau.

4. Limitations

- 4.1. An International Course Designer must meet the qualifications for an International Course Designer, be recommended by his NF, and be appointed by the FEI Driving Committee within five years of becoming an International Candidate Course Designer. At the end of the five year period the International Candidate will either be promoted or dropped from the list.
- 4.2. International Course Designers who are no longer able or willing to act regularly will be removed from the FEI list by the FEI Driving Committee.

Rules for International Combined Driving Events

- 4.3 Course Designers of all categories must retire at the end of the year in which they reach the age of 70. In very special circumstances and on the recommendation of the FEI Driving Committee the age limit may be extended for a further four years.
- 4.4 To retain their status, Course Designers must attend a clinic or seminar every four years for their respective category. Otherwise they may be removed from the list at the discretion of the Driving Committee.
- 4.5 A Course Designer must officiate as Course Designer at an international event at least once every five years or, at the discretion of the Driving Committee, have his name removed from the FEI list of Course Designers.

Rules for International Combined Driving Events

ANNEX 3 CLASSIFICATION OF TECHNICAL DELEGATES

1. Categories of Technical Delegates

Technical Delegates are divided into three categories.

- 1.1 International Candidate Technical Delegate.
- 1.2 International Technical Delegate.
- 1.3 Official International Technical Delegate.

2. Qualification requirements for Technical Delegates

2.1 International Candidate Technical Delegate.

The qualification requirements to become an International Candidate Technical Delegate are as follows:

- 2.1.1 To have had regular practice as a National Technical Delegate over a period of at least five years, as well as having acted as Technical Delegate at two CANs under FEI rules. Experience on Organising Committees, as well as having worked with a Course Designer is required. This requirement may be reduced if the Technical Delegate is an International Judge or an International Course Designer.
- 2.1.2 To have served as an assistant to an International Technical Delegate at a CAI A or CAIO.
- 2.1.3 To understand one of the official two languages.
- 2.1.4 To have attended and passed at least one FEI Course for International Candidate Technical Delegates.

2.2 International Technical Delegate.

The qualification requirements to become an International Technical Delegate are as follows:

- 2.2.1 To have acted as International Candidate Technical Delegate at one CAI B during the current or preceding year.
- 2.2.2 To have qualified at an FEI Course for International Technical Delegates within the past four years.
- 2.2.3 To understand and speak one of the official two languages.

2.3 Official International Technical Delegate.

The qualification requirements to become an Official International Technical Delegate are as follows:

- 2.3.1 To fulfil and continue to fulfil the qualification requirements for International Technical Delegates.
- 2.3.2 To have had considerable experience proven by excellent performance as Technical Delegate at major FEI Events.

3. Promotion of Technical Delegates

3.1 International Candidate Technical Delegate

The FEI maintains a list of qualified International Candidate Technical Delegates who have been recommended by their NF and who have been accepted by the FEI Driving Committee. They must meet the qualification requirements for International Candidate Technical Delegates before they may be recommended by their NF.

3.2 International Technical Delegate.

The FEI maintains a list of qualified International Technical Delegates who have been appointed and recommended by the FEI Driving Committee following receipt of recommendation from the relevant NF. They must meet the qualification requirements for International Technical Delegates before they may be appointed.

3.3 Official International Technical Delegate.

The FEI maintains a list of qualified Official International Technical Delegates who have been selected by the Bureau from the list of International Technical Delegates after consultation with the FEI Driving Committee.

4. Limitations

- 4.1 An International Candidate Technical Delegate must meet the qualification requirement laid down for International Technical Delegates, be recommended for promotion to the status of International Technical Delegate by his NF and be promoted by the FEI Driving Committee within five years of becoming an International Candidate Technical Delegate. At the end of the five year period International Candidate Technical Delegates will either be promoted or dropped from the list.

Rules for International Combined Driving Events

- 4.2 International Technical Delegates who are no longer able or willing to act regularly will be removed from the FEI list by the FEI Driving Committee.
- 4.3 Technical Delegates of all categories must retire at the end of the year in which they reach the age of 70. In very special circumstances and on recommendation of FEI Driving Committee the age limit may be extended for a further four years.
- 4.4 A Technical Delegate must officiate as Technical Delegate at an International Event at least once every five years or, at the discretion of the Driving Committee, have his name removed from the FEI list of Technical Delegate.
- 4.5 To retain their status, Technical Delegates must attend a clinic or seminar every four years for their respective category. Otherwise they may be removed from the list at the discretion of the Diving Committee.

ANNEX 4 DIAGRAM OF THE DRESSAGE ARENA for Test 8a

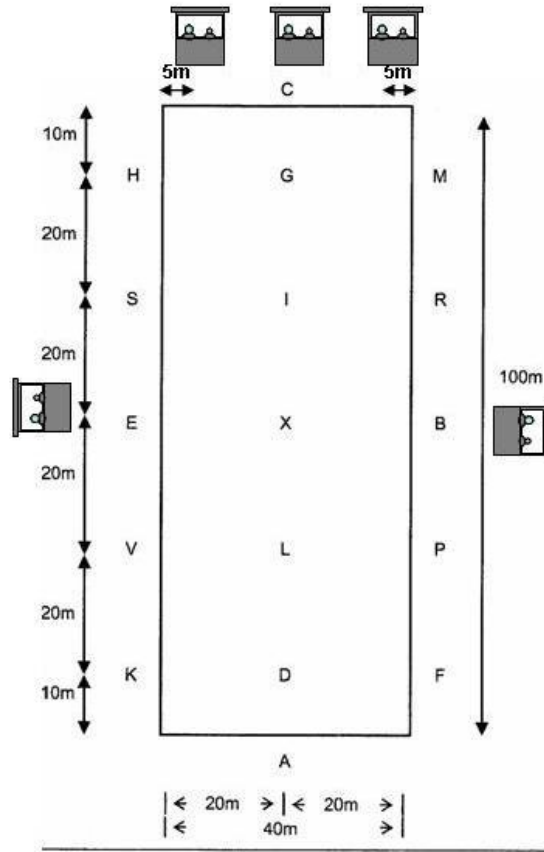

Rules for International Combined Driving Events

ANNEX 5 DIAGRAM OF THE SMALL DRESSAGE ARENA

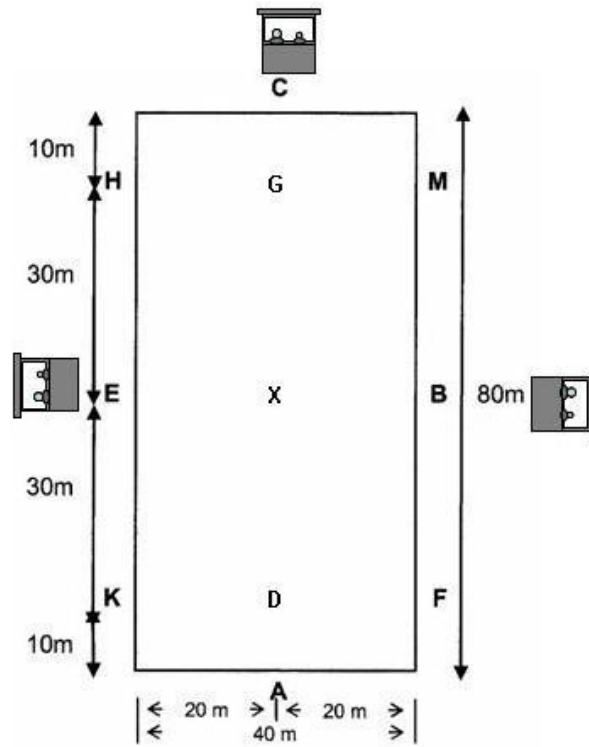

Rules for International Combined Driving Events

ANNEX 6 RULE DIFFERENCES FOR FIVE SECTION MARATHONS

The following modified Articles shall be used for a Competition B Marathon Course of 5 sections.

Article 941 THE COURSE

1. Distances and speeds:
- 2.

Section	Max Distance	Min. Distance	Paces	Maximum Speed km/hour	
				Horse	Pony
A	8000m	5000m	free	15	14
B	1000m	800m	walk	7	6
C	4000m		trot	19	17
D	1000m	800m	walk	7	6
E	9000m*	6000m	free	14	13

* At least 1 km per Obstacle.

2. Compulsory Rests
 - 2.1 There must be a Compulsory Rest of at least 10 minutes at the end of Section D timed while the Entry is within the designated Veterinarian Inspection Area.
 - 2.5 In the event of exceptional circumstances, the Minimum time required for the Compulsory Rests (after Sections B & D) may be increased at the discretion of the Ground Jury.

Rules for International Combined Driving Events

ANNEX 7 CLOSED MULTIPLE OBSTACLES

(Elements must be separated 20 cm – 40 cm)

1. Single "L"

Construction:

Sports – 40 cm to 60 cm from ground to top of rail

Elements – must be free standing; parallel or perpendicular

Single or sectioned rails; separated by 20 cm-40 cm Spacing

Markers – a pair of red and white markers, set within 15 cm

Element. < A > at the IN gate and << B >> at the OUT gate

Horse: (minimum measurements)

	IN	A1	A2	B1	B2	OUT
Single	3	8	11	8	11	3
Pair	3	8	11	8	11	3
Tandem	4	8	12	8	12	4
Four in Hand	4	8	12	8	12	4

Pony: (minimum measurements)

	IN	A1	A2	B1	B2	OUT
Single	3	8	11	8	11	3
Pair	3	8	11	8	11	3
Tandem	3	8	11	8	11	3
Four in Hand	3	8	11	8	11	3

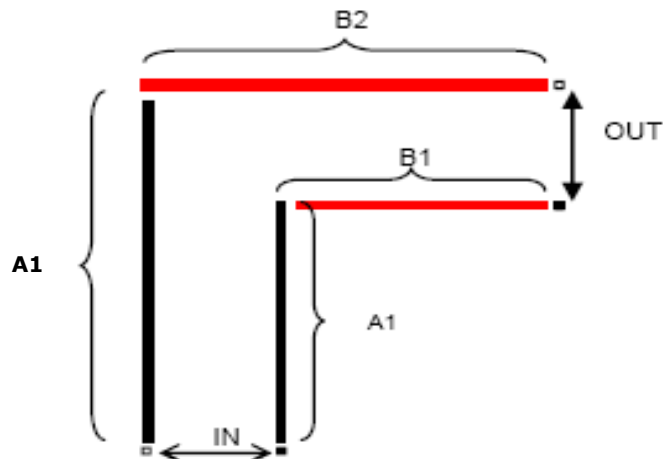

Rules for International Combined Driving Events

2. Double "L"

Construction:

Supports – 40 cm to 60 cm from ground to top of rail

Elements – must be free standing; parallel or perpendicular

Single or sectioned rails; separated by 20 cm-40 cm

Spacing.

Markers – indicating each section as follows:

A- within 15 cm of IN.

B – coloured or wrapped rails or markers on the ground.

C – within 15 cm of OUT..

Horse: (minimum measurements)

	IN	AI	A2	B	B1	B2	C	C1	C2	OUT
Single	3	5	9	4	10	9	4	9	5	4
Pair	3	5	9	4	10	9	4	9	5	4
Tandem	4	5	10	5	10	9	5	10	5	5
Four in Hand	4	5	10	5	10	9	5	10	5	5

Pony: (minimum measurements)

	IN	AI	A2	B	B1	B2	C	C1	C2	OUT
Single	3	5	9	4	9	9	4	9	5	4
Pair	3	5	9	4	9	9	4	9	5	4
Tandem	3	5	9	4	9	9	4	9	5	4
Four in Hand	3	5	9	4	9	9	4	9	5	4

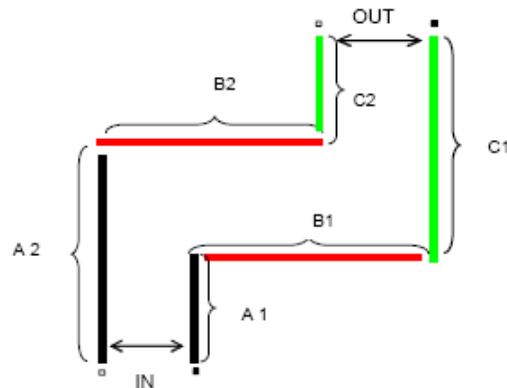

Rules for International Combined Driving Events

3. Single "U"

Construction:

Supports – 40 cm to 60 cm from ground to top of rail

Elements – must be free standing; parallel or perpendicular

Single or sectioned rails; separated by 20 cm-40 cm

Spacing

Markers – indicating each section as follows:

- A - within 15 cm of IN.
- B - coloured or wrapped rails or markers on the ground.
- C - outside but within 15 cm of C.

Horse: (minimum measurements)

	IN	A1	B	B1	B2	C1	OUT
Single	3	9	4	5	7	9	4
Pair	3	9	4	5	7	9	4
Tandem	4	9	5	5	9	10	5
Four in Hand	4	9	5	5	9	10	5

Pony: (minimum measurements)

	IN	A1	B	B1	B2	C1	OUT
Single	2	8	3	5	5	8	3
Pair	3	9	4	5	7	9	4
Tandem	3	9	4	5	7	9	4
Four in Hand	3	9	4	5	7	9	4

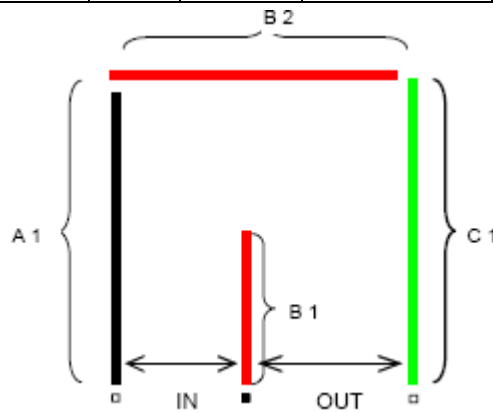

Rules for International Combined Driving Events

4. Double "U"

Construction:

Supports – 40 cm to 60 cm from ground to top of rail

Elements – must be free standing; parallel or perpendicular

Single or sectioned rails; separated by 20 cm-40 cm

Spacing

Markers – indicating each section as follows:

A- within 15 cm of IN.

B, C – coloured or wrapped rails or markers on the ground.

D – within 15 cm of OUT.

Horse: (minimum measurements)

	IN	AI	B	B1	B2	C	C1	C2	D1	OUT
Single	3	12	4	8	7	4	8	8	12	4
Pair	3	12	4	8	7	4	8	8	12	4
Tandem	4	13	5	8	9	5	8	10	13	5
Four in Hand	4	13	5	8	9	5	8	10	13	5

Pony: (minimum measurements)

	IN	AI	B	B1	B2	C	C1	C2	D1	OUT
Single	2	9	3	6	5	3	6	6	9	3
Pair	3	12	4	8	7	4	8	8	12	4
Tandem	3	12	4	8	7	4	8	8	12	4
Four in Hand	3	12	4	8	7	4	8	8	12	4

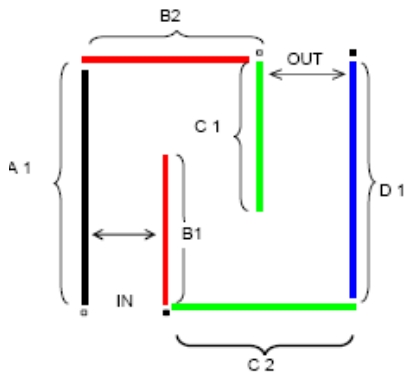

Rules for International Combined Driving Events

5. Box

Construction:

Supports – 40 cm to 60 cm from ground to top of rail

Elements – must be free standing; parallel or perpendicular

Single or sectioned rails; separated by 20 cm-40 cm

Spacing

Markers – indicating each section as follows:

A- within 15 cm of IN.

B – coloured or wrapped rails or markers on the ground.

C – outside but within 15 cm of C.

Horse: (minimum measurements)

	IN	AI	A2	B	B1	B2	C1	C2	OUT
Single	3	4	8	4	7	8	4	7	4
Pair	3	4	8	4	7	8	4	7	4
Tandem	4	5	9	5	8	10	5	8	5
Four-in-Hand	4	5	9	5	8	10	5	8	5

Pony: (minimum measurements)

	IN	AI	A2	B	B1	B2	C1	C2	OUT
Single	2	3	7	3	6	6	3	6	3
Pair	3	4	8	4	7	8	4	7	4
Tandem	3	4	8	4	7	8	4	7	4
Four-in-Hand	3	4	8	4	7	8	4	7	4

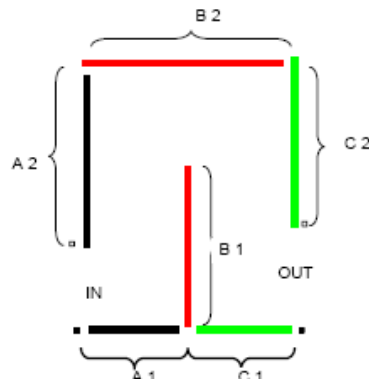

Rules for International Combined Driving Events

6. Double Box

Construction:

Supports – 40 cm to 60 cm from ground to top of rail

Elements – must be free standing; parallel or perpendicular

Single or sectioned rails; separated by 20 cm-40 cm

Spacing

Markers – indicating each section as follows:

A- within 15 cm of IN.

B, C – coloured or wrapped rails or markers on the ground.

D – within 15 cm of OUT.

Horse: (minimum measurements)

	IN	A1	A2	B	B1	B2	C	C1	C2	D1	D2	OUT
S	3	4	8	4	7	8	4	7	8	7	4	4
P	3	4	8	4	7	8	4	7	8	7	4	4
T	4	5	9	5	8	10	5	8	10	8	5	5
4	4	5	9	5	8	10	5	8	10	8	5	5

Pony: (minimum measurements)

	IN	A1	A2	B	B1	B2	C	C1	C2	D1	D2	OUT
S	2	3	8	3	7	6	3	7	6	7	3	3
P	3	4	8	4	7	8	4	7	8	7	4	4
T	3	4	8	4	7	8	4	7	8	7	4	4
4	3	4	8	4	7	8	4	7	8	7	4	4

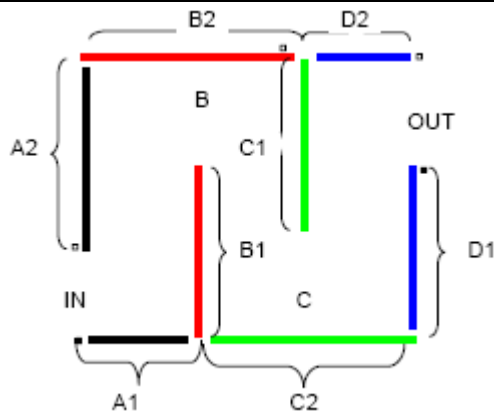

ANNEX 8 OPEN MULTIPLE OBSTACLES

1. SERPENTINE Art 952.3

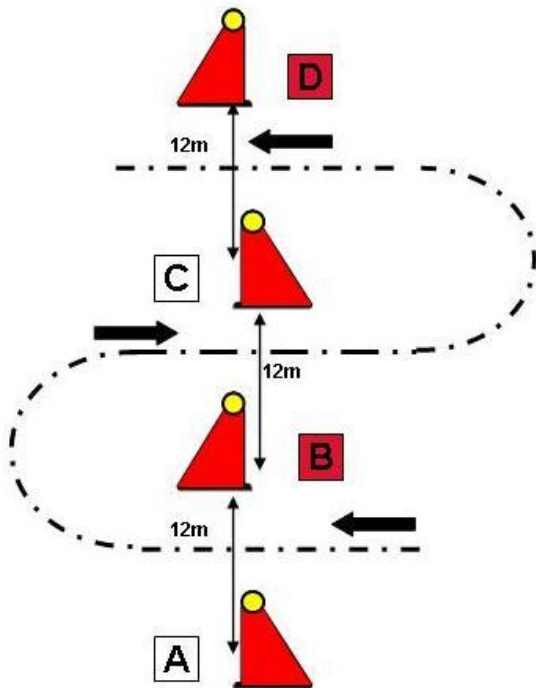

Minimum distance between Cones Centre to Centre

	Horses	Ponies
Four-in-Hand	12m	10m
Pair	8m	8m
Tandem	12m	10m
Single	8m	8m

Cones to be set in a straight line with Marker on opposite sides.

Rules for International Combined Driving Events

2. ZIG-ZAG: Art 952 .3

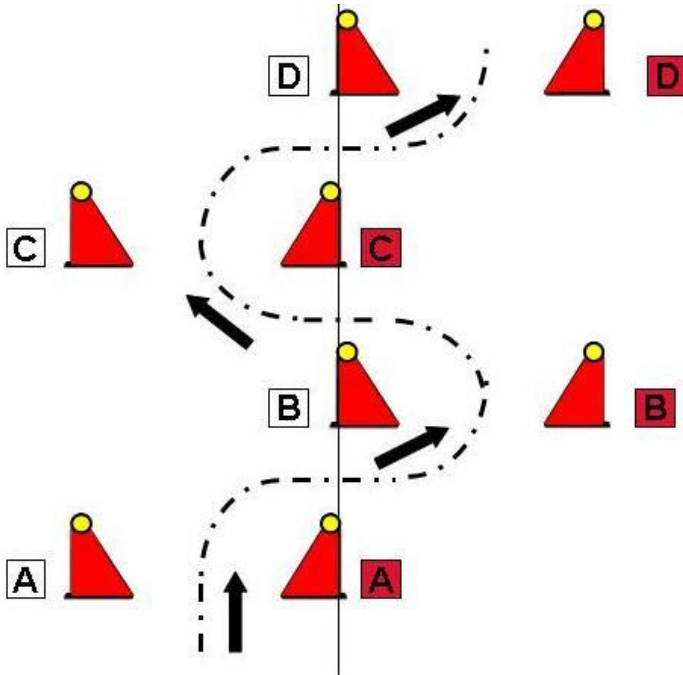

Minimum distance between Cones Centre to Centre

	Horses	Ponies
Four-in-Hand	12m	10m
Pair	11m	10m
(See 953 1.1 Technical summary)		
Tandem	12m	10m
Single	11 m	10m

Centre line cones to be set in a straight line, either in front, at the Middle or at the rear of the cone (as shown above) with markers Placed within 15 cm.

The centre line cone shall not be adjusted, the outside cone shall Be set to the required track width.

Rules for International Combined Driving Events

ANNEX 9 THE BRIDGE. Art 952.4

Dimensions:

10m x 3m; maximum 20 cm high with fan shaped wings

Cones required at both ends adjacent to bridge, with red and White letters A at entrance and letters B at exit, set at a Constant clearance of 2.5 meters for all classes.

